

Tipos Básicos

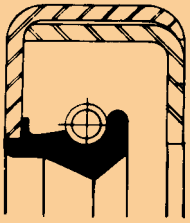

B

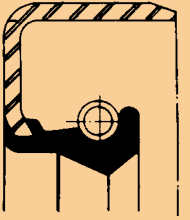

BA

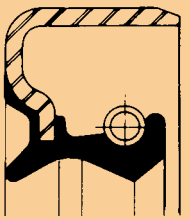

BAG

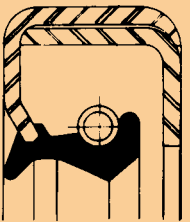

BG

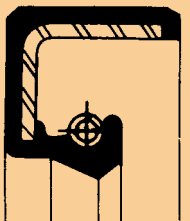

BR

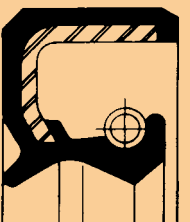

BRG

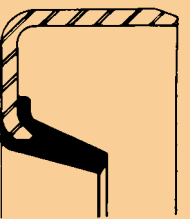

GA

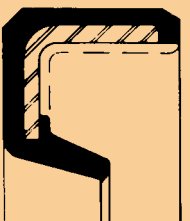

GR

Índice

Como Utilizar este Catálogo.....	05
Função do Retentor.....	06
Características do Lábio de Vedação.....	06
Materiais Elastoméricos.....	07
Recomendações quanto à Aplicação.....	08
Recomendações quanto à Superfície do Eixo.....	09
Recomendações quanto às Condições de Montagem.....	10
Normalização de Medidas.....	12
Conceitos Básicos de Construção.....	13
Tipos Básicos.....	14
Grupo A - Tipos Alternativos.....	26
Tipos Especiais	
Grupo B - Retentores com 2 Alturas.....	29
Grupo C - Retentores para Sistemas Hidráulicos.....	31
Grupo D - Retentores para Movimento Axial.....	32
Grupo E - Pista para o Vedador.....	34
Grupo F - Retentores para Haste de Válvulas.....	35
Grupo G - Retentores para Vedação Externa.....	36
Grupo H - Tampão.....	37
Grupo I - Retentores Especiais.....	38
Grupo J - Arruela para Vedação.....	39
Grupo K - Retentores com Aba no Externo.....	40
Grupo L - Retentores Integrados.....	41
Grupo M - Retentores com Pista Própria.....	42
Grupo N - Só Borracha.....	43
Grupo O - Retentores Fixados por Parafusos.....	44
Grupo P - Retentores de Metal e Ferro.....	45
Grupo Q - Retentores de Feltro.....	46
Grupo R - Retentores Estampados.....	47
Grupo S - Retentores em PTFE.....	48
Grupo T - Sistema de Vedação.....	49
Grupo U - Retentores Tipo "S".....	50
Índice Numérico (Ordem Crescente Nº Sabó).....	52

Como utilizar este catálogo

Para consultar este catálogo veja as instruções abaixo:

Tipos Básicos

SABO Retentores													
A B C D E F G													
Diâmetro do eixo	Diâmetro do alojamento	Altura do retentor	Número Sabó	Função	Orientação	Material	Diâmetro do eixo	Diâmetro do alojamento	Altura do retentor	Número Sabó	Função	Material	
5,0	14,50	4,5	02524	BR	LI	NBR	12,7	25,20	9,5	02528	BR	LI	NBR
6,0	16,00	5,5	02515	GR	LI	CR	12,7	25,20	6,4	00981	GA	LI	NBR
6,0	16,00	6,5	02512	BRG	LI	NBR	12,7	25,20	6,4	02166	BA	BI	NBR
6,4	16,05	6,4	00987	BA	LI	NBR	12,7	25,40	9,5	00139	BR	LI	NBR
6,4	16,10	6,4	01005	BR	LI	NBR	12,7	25,50	9,5	00211	B	LI	NBR
6,5	14,50	7,0	02336	BRG	LI	NBR	12,7	25,55	6,5	01657	BA	BI	NBR
7,0	16,00	7,0	02338	BA	LI	NBR	12,7	30,00	8,0	01987	BR	LI	NBR
7,7	14,85	5,0	02076	GR	LI	NBR	13,0	30,00	7,0	02372	BRG	LI	NBR
7,8	13,80	3,6	02198	GR	LI	NBR	13,0	30,00	9,0	01974	BRG	LI	NBR
7,8	14,10	3,6	01984	GA	LI	NBR	14,0	20,00	3,5	02302	BA	LI	NBR
7,8	14,40	4,8	02462	GRF	LI	PPM	14,0	20,00	4,0	02369	BRGP	LI	ACM
8,0	14,00	3,0	02465	BRF	LI	PPM	14,0	20,00	5,0	02352	BRG	BI	NBR
8,0	14,00	3,0	02335	BR	LI	NBR	14,0	20,00	6,0	01977	GA	LI	NBR
8,0	15,00	3,0	02491	GR	LI	NBR	14,0	24,00	6,0	02162	BRG	LI	NBR
8,0	15,00	5,5	02762	BR	LI	NBR	14,0	24,00	7,0	01389	BAG	LI	NBR
8,0	16,00	7,0	02013	BRP	H	ACM	14,0	28,00	7,0	02330	BRG	LI	NBR
8,0	17,45	8,0	02196	BA	LI	NBR	14,0	30,00	10,0	01972	BR	LI	NBR
8,0	18,00	5,0	01423	BR	LI	NBR	14,3	22,00	3,9	01977	GR	LI	NBR
8,0	18,00	5,0	02163	BRG	LI	NBR	14,3	22,00	7,0	01935	BR	LI	NBR
8,0	22,00	8,0	01587	BR	LI	NBR	14,3	24,40	9,5	00716	B	LI	NBR
8,5	16,00	6,5	00998	BR	H	NBR	14,3	28,00	6,4	02033	BR	LI	NBR
9,0	21,40	5,0	02046	GA	LI	NBR	14,3	28,00	9,5	00941	B	LI	NBR
9,5	19,00	7,0	01803	BR	H	NBR	14,3	35,00	6,3	02334	BAG	LI	NBR
9,5	19,20	7,0	01803	BR	H	NBR	15,0	21,00	3,5	02389	GR	LI	NBR
9,5	20,25	8,5	00989	B	LI	NBR	15,0	21,00	4,0	02130	BAG	LI	NBR
10,0	14,00	3,0	02135	GA	LI	NBR	15,0	21,00	5,0	02787	BRAGP	LI	ACM
10,0	18,00	6,5	02171	BR	LI	NBR	15,0	22,00	3,0	02039	GR	LI	NBR
10,0	21,00	5,0	02065	BR	AH	NBR	15,0	24,00	7,0	02790	BR	LI	NBR
10,0	22,00	7,0	01472	BR	LI	NBR	15,0	24,00	7,0	01473	BRG	LI	NBR
10,0	22,00	7,0	01984	BRP	H	ACM	15,0	24,00	7,4	01916	BA	AH	NBR
10,0	22,00	7,0	02166	BR	AH	NBR	15,0	28,00	7,0	02399	BRP	AH	ACM
10,0	30,00	7,0	00764	BA	LI	NBR	15,0	28,00	7,0	02454	BRG	LI	NBR
10,3	16,00	4,0	02091	GA	LI	NBR	15,0	28,00	6,0	02279	BAG	LI	NBR
10,8	22,20	5,4	01987	BR	LI	NBR	15,0	28,00	7,0	00616	BA	LI	NBR
11,0	17,00	4,0	01737	BR	LI	NBR	15,0	28,50	8,0	01976	B	LI	NBR
11,0	17,00	4,0	02023	BRF	LI	PPM	15,0	30,00	5,0	00616	GA	LI	NBR
11,1	22,20	6,5	02474	BRG	LI	NBR	15,0	30,00	6,0	01915	BAGP	LI	ACM
11,1	25,40	6,0	01479	BR	LI	NBR	15,0	30,00	7,0	02077	BR	LI	NBR
11,4	24,00	10,0	01468	BRGP	LI	ACM	15,0	30,00	7,0	01946	BAG	LI	NBR
12,0	18,00	3,0	02038	GR	LI	NBR	15,0	30,00	8,0	00766	BA	LI	NBR
12,0	18,00	5,0	02148	BR	BI	NBR	15,0	30,00	10,0	01348	BR	LI	NBR
12,0	20,00	5,0	02069	BAG	LI	NBR	15,0	30,00	7,0	01987	BR	LI	NBR
12,0	21,00	4,0	02325	BR	LI	NBR	15,0	30,00	7,0	01958	BR	LI	NBR
12,0	22,00	5,0	02330	BRG	LI	NBR	15,0	30,00	7,0	01959	BAG	LI	NBR
12,0	22,00	7,0	02098	BA	LI	NBR	15,0	30,00	9,0	01951	BR	LI	NBR
12,0	28,00	8,0	02792	BAG	LI	NBR	15,0	32,00	4,3	02335	BAG	LI	NBR
12,0	28,10	7,0	01400	BR	LI	NBR	15,0	32,00	4,8	00819	GA	LI	NBR
12,0	30,00	7,0	01445	BA	LI	NBR	15,0	35,00	6,4	01475	BA	LI	NBR
12,5	20,00	5,0	02360	BRF	BI	PPM	15,0	35,40	4,5	00616	B	LI	NBR
12,5	20,00	6,0	02036	BRG	LI	NBR	15,0	35,00	7,0	01403	BR	LI	NBR
12,6	21,40	5,0	02049	GA	LI	NBR	15,0	35,50	9,5	00016	B	LI	NBR
12,7	22,20	8,0	01959	BR	LI	NBR	15,0	30,00	6,0	02334	BAG	H	NBR
12,7	22,20	8,0	02334	BRP	LI	ACM	15,0	30,00	4,5	01786	GR	LI	NBR

Tipos Básicos Legendas

BR = Validação principal de borachas com meia, proteção contra poeira e incidência externamente com boracha.

BRG = Validação principal de borachas com meia, proteção contra poeira e incidência externamente com boracha.

BA = Validação principal de borachas com meia e diâmetro externo de metal.

BAG = Validação principal de borachas com meia, diâmetro externo de metal e com Tampa.

B = Validação principal de borachas com meia, diâmetro externo de metal.

BG = Validação principal de borachas com meia, proteção contra poeira e com Tampa.

GR = Validação principal de borachas sem meia e diâmetro externo com boracha.

GA = Validação principal de borachas sem meia e diâmetro externo de metal.

Ilustrações dos Tipos Básicos

Retentores pelo diâmetro do eixo e agrupados pela função (Tipos Básicos, Tipos Alternativos e Tipos Especiais)

Legendas

Como localizar o retentor desejado

1) Tipos Básicos (páginas 14 a 25)

Conhecendo-se o diâmetro do eixo, localizá-lo na coluna "Diâmetro do eixo" (A), onde encontrará as informações complementares: Diâmetro do alojamento (B), Altura do retentor (C), número Sabó (D), Tipo (E), Orientação (F) e Material do lábio (G).

2) Tipos Alternativos e Tipos Especiais (páginas 26 a 50)

Conhecendo-se a função e o diâmetro do eixo, localizar dentro dos Grupos A a U (H) o perfil do retentor desejado e, pelo diâmetro do eixo, chegar às informações complementares. As ilustrações correspondentes (I) encontram-se ao lado do texto de cada grupo, sendo que os tipos identificados com expoente numérico (-) possuem perfil específico.

3) Índice Numérico (páginas 52 a 69)

Conhecendo-se o número Sabó, localize-o no Índice Numérico onde encontrará o diâmetro do eixo. Caso o retentor encontrado seja Tipo Alternativo ou Tipo Especial, estará indicado o grupo a que pertence. Para informações complementares, proceder conforme descrito acima nos itens 1 e 2.

Função do retentor

O vedador do lábio ou retentor, como é usualmente conhecido, é composto essencialmente de uma membrana elástica em forma de “lábio” e uma parte estrutural metálica, que permite a fixação do lábio na posição correta de trabalho na aplicação.

O retentor tem por função primordial reter óleos, graxas ou outros fluidos que devam ser contidos no interior de uma máquina ou um agregado mecânico.

O retentor é sempre aplicado entre duas peças que tenham um movimento relativo, por exemplo: entre um eixo que transmite um movimento e a carcaça de sustentação do mancal deste eixo (figura 1).

Ele cumpre esta função de vedação tanto na condição estática, de máquina parada, como na condição dinâmica, em movimento, e também na variedade de condições de temperatura e meio externo para as quais a máquina está projetada.

A vedação se dá pelo contato permanente que ocorre entre a aresta do lábio de vedação e o eixo da máquina. Para completar a estanqueidade com o meio externo, é preciso que haja também a vedação entre a parte externa estrutural do vedador e a carcaça.

Características do lábio de vedação

Partindo-se do lábio convencional como ilustrado na figura 2, pode-se obter uma maior eficiência de vedação adicionando-se nervuras moldadas ao ângulo de ar, que proporcionam o conhecido efeito hidrodinâmico de vedação.

Este efeito hidrodinâmico promove o refluxo ao óleo que, eventualmente, tenha ultrapassado a aresta de vedação, conferindo assim ao lábio uma maior capacidade de estanqueidade, e ainda, uma maior durabilidade, por garantir uma permanente lubrificação na área de contato sob a aresta de vedação.

Existem várias formas geométricas de nervuras hidrodinâmicas, cuja escolha é determinada pelas condições de aplicação do vedador.

Fig. 1

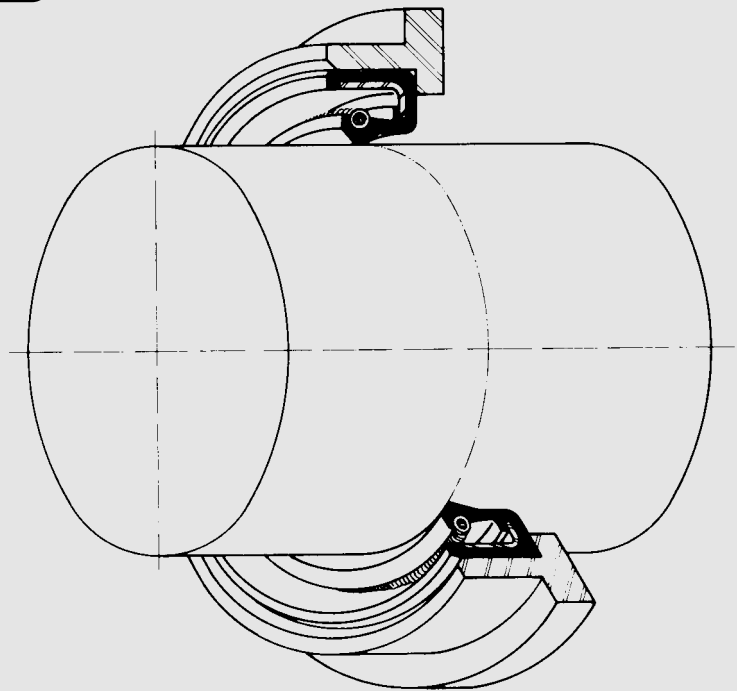
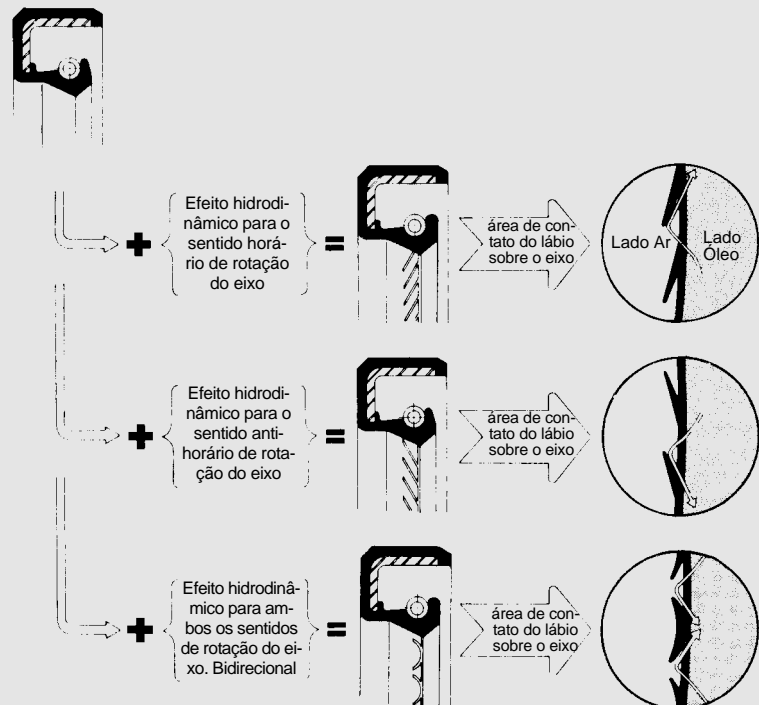
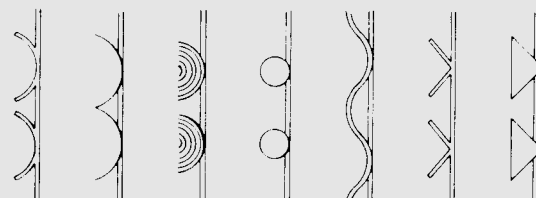

Fig. 2

Ilustração do Efeito Hidrodinâmico



Exemplos de configuração das nervuras bidirecionais



Materiais elastoméricos

Como já citado anteriormente, a vedação se dá por meio da interferência do lábio elastomérico sobre o eixo. Esta condição de trabalho provoca o aparecimento de uma força de atrito na área do lábio com a direção do movimento do eixo e sentido contrário ao mesmo.

A força de atrito e a velocidade periférica do eixo tornam-se responsáveis por uma geração de calor localizada na área de contato do lábio, que tende a promover a degeneração do material e o desgaste do lábio de vedação.

A contenção destes efeitos é conseguida primordialmente pela escolha correta do material elastomérico. É de suma importância que esta escolha seja definida em conjunto com o fabricante do vedador, pois há uma série de fatores de projeto que devem ser igualmente considerados para conferir uma vida prolongada ao vedador.

Na figura 3 estão mostradas as várias qualidades de elastômeros e recomendações genéricas de uso para os diferentes fluidos e limites de temperaturas de trabalho.

Código do elastômero, de acordo com as Normas ISO 1629 e DIN 3761	Tipo de Borracha	Limite de temperatura mínima de trabalho (°C)	Límites de Temperatura máxima de trabalho (°C)							Aplicações Gerais
			Óleos para motor	Óleo para Caixa de Mudanças	Óleos Hipóides	Óleos p/ Transm. Automática (A.T.F.)	Graxa	Gasolina + Óleo Motor 2T	Álcool + Aditivos	
NBR	Nitrílica	-35	110	110	110	120	90	100	100	Material normalmente utilizado para máquinas e equipamentos industriais. Muito utilizado na indústria automotiva para aplicações gerais.
ACM	Poliacrílica	-15	130	120	120	130	-	-	-	Material largamente utilizado para motores e transmissões na indústria automobilística.
MVQ	Silicone	-50	150	-	-	130	-	-	-	Material usualmente empregado em motores de elevado desempenho e em conversores de torque de transmissões automáticas.
FPM	Fluorelastômetro	-30	150	150	150	150	-	125	125	Material empregado em motores e transmissões, altamente solicitados.

Fig. 3

Na figura 4 é mostrado um gráfico que indica os limites de velocidade periférica do eixo para cada material, prevendo-se que haja uma boa lubrificação do lábio e também que a pressão interna da máquina seja praticamente igual à pressão externa.

Estas considerações para escolha do material elastomérico devem ser consideradas somente como uma orientação geral. Recomendamos portanto, que para cada nova aplicação de vedador, o projeto seja previamente discutido com a Engenharia de Produtos da Sabó.

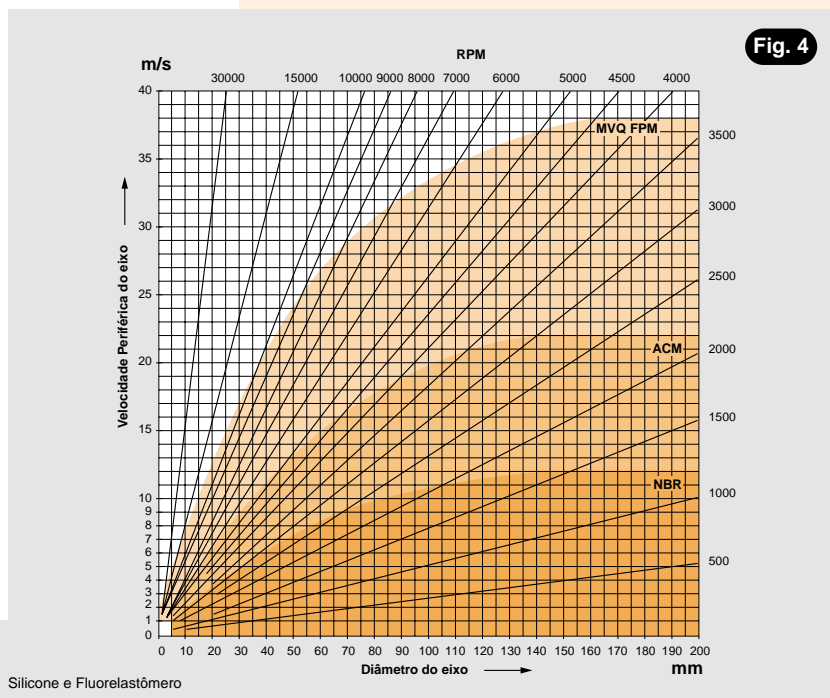

Fig. 4

Recomendações quanto à aplicação

Execução do alojamento: (figura 5)

A seguir estão descritas as recomendações para execução do alojamento, as quais se aplicam a todos os tipos de vedadores.

Para o diâmetro do furo do alojamento D_F deve ser prevista a tolerância ISO H8.

O vedador geralmente é retido no alojamento por interferência entre os diâmetros do alojamento D_F e o externo do D_R e sua montagem deve ser executada com auxílio de uma prensa hidráulica. Os valores recomendados para esta interferência, bem como as tolerâncias de D_F e D_R , segundo a norma DIN 3761, estão mostrados na figura 6.

O acabamento da superfície do furo poderá ser obtido por usinagem fina com rugosidade de até $R_t 25\mu$.

Deste modo será garantida uma boa retenção e estanqueidade entre o retentor e o alojamento.

Para se obter uma boa condição de montagem do retentor, deve ser previsto um chanfro de entrada no início do alojamento, com inclinação da ordem de 5° a 15° , numa profundidade de 0,8 mm mínimo. Os cantos desta superfície chanfrada deverão estar livres de rebarbas de usinagem.

Execução do eixo de trabalho: (figura 5)

Para o diâmetro do eixo d deverá ser prevista a tolerância conforme recomendação da norma DIN 3761, ISO h11.

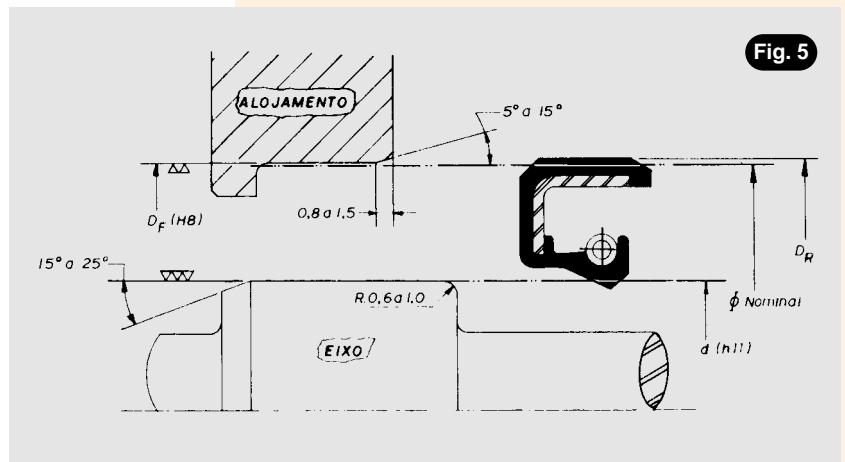

Fig. 5

Fig. 6

Tolerância de D_F e D_R e interferência resultante
Dimensões em milímetro

ø Nominal	Tol. D_F (H8)	Retentor tipo BR		Retentor tipo BA ou B	
		Tol. D_R	Interferência Resultante	Tol. D_R	Interferência Resultante
de 10 a 18	0 + 27	+ 0,30 + 0,15	+ 0,300 + 0,123	+ 0,20 + 0,10	+ 0,200 + 0,073
de 18 a 30	0 + 33	+ 0,30 + 0,15	+ 0,300 + 0,117	+ 0,20 + 0,10	+ 0,200 + 0,067
de 30 a 50	0 + 39	+ 0,30 + 0,15	+ 0,300 + 0,111	+ 0,20 + 0,10	+ 0,200 + 0,061
de 50 a 80	0 + 46	+ 0,35 + 0,20	+ 0,350 + 0,154	+ 0,23 + 0,13	+ 0,230 + 0,084
de 80 a 120	0 + 54	+ 0,35 + 0,20	+ 0,350 + 0,146	+ 0,25 + 0,15	+ 0,250 + 0,096
de 120 a 180	0 + 63	+ 0,45 + 0,25	+ 0,450 + 0,187	+ 0,28 + 0,18	+ 0,280 + 0,117
de 180 a 300	0 + 72	+ 0,45 + 0,25	+ 0,450 + 0,178	+ 0,30 + 0,20	+ 0,300 + 0,128

Exemplos de utilização:

— Cálculo de $D_F = \varnothing + \text{Tol. } D_F$ Ex. $D_{F_{\min}} = 65 + 0,000 = 65,000$

$D_{F_{\max}} = 65 + 0,046 = 65,046$

— Cálculo de $D_R = \varnothing + \text{Tol. } D_R$ Ex. $D_{R_{\min}} = 65 + 0,200 = 65,200$

$D_{R_{\max}} = 65 + 0,350 = 65,350$

Cálculo da Interferência Resultante:

$\text{Int}_{\max} = D_{R_{\max}} - D_{F_{\min}}$ Ex. $65,350 - 65,000 = 0,350 = \text{Int}_{\max}$

$\text{Int}_{\min} = D_{R_{\min}} - D_{F_{\max}}$ Ex. $65,200 - 65,046 = 0,154 = \text{Int}_{\min}$

Recomendações quanto à superfície do eixo

Objetivando conferir uma boa durabilidade e eficiência de trabalho ao retentor, a superfície do eixo onde trabalha o lábio deverá atender as seguintes exigências:

- O acabamento final desta superfície deve ser obtido por operação de retífica de topo com valores de rugosidade RA dentro de 0,2 a 0,5 μ ou Rt de 1.60 a 4.0 μ . Nesta operação de retífica, deverão ser evitados os movimentos transversais do rebolo, que possam imprimir riscos com orientação helicoidal na superfície do eixo.
- A superfície de trabalho do lábio do retentor deve ser isenta de danificações, tais como: batidas, sulcos, trincas, falhas de material, oxidações ou deformações.
- A dureza do eixo na região de trabalho do retentor deverá estar acima de **28 RC**.

Visando uma boa condição de montagem, de modo que o lábio do retentor não sofra danificações ou deformações no ato da instalação, é recomendável que os cantos dos eixos sejam chanfrados com inclinação de 15 a 25° ou arredondados com raio de 0,6 a 1,0 mm na região que passa sob o lábio. Os cantos devem ser arredondados e livres de rebarbas.

É importante também que o lábio de vedação durante a instalação do vedador evite contato direto com regiões do eixo contendo rasgos de chaveta, entalhados ou com usinagem grosseira. Caso isto seja inevitável, deve-se prover uma luva protetora com superfície em seu diâmetro externo respeitando as mesmas recomendações sugeridas para o eixo de trabalho.

Tolerâncias de excentricidade do alojamento:

Devido a inevitáveis variações de usinagem do alojamento e do mancal, é previsto que haja uma certa excentricidade entre os mesmos. Em outras palavras, a linha de centro geométrico do alojamento do retentor não coincide exatamente com a linha de centro efetiva de giro do eixo (figura 7). A distância entre estas duas linhas de centros, assim definida como excentricidade estática, deverá ser mantida dentro dos limites estreitos indicados na figura 8.

Tolerâncias de excentricidade do eixo:

Igualmente é previsto que na usinagem do eixo haja uma certa excentricidade entre a linha de centro efetiva de giro do eixo e a linha de centro do diâmetro da pista de trabalho do retentor (figura 9). A excentricidade dinâmica, assim definida, também deverá estar contida dentro dos valores recomendados na figura 10.

Para valores muito acima dos recomendados, haverá o risco do lábio de vedação, devido à sua inércia, não conseguir manter o contato com o eixo. Principalmente no caso de elevadas velocidades angulares.

Fig. 7

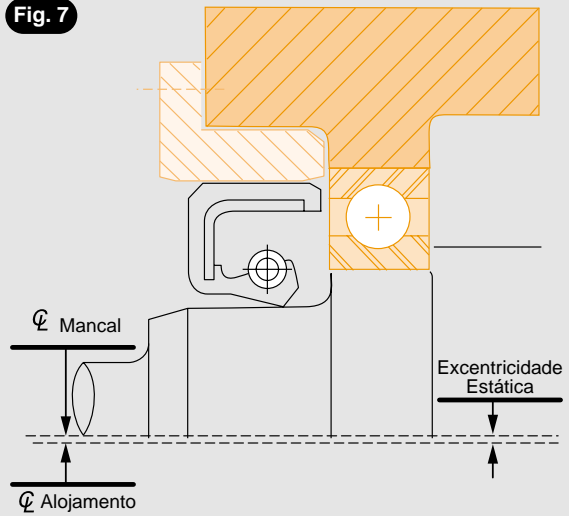

Fig. 8

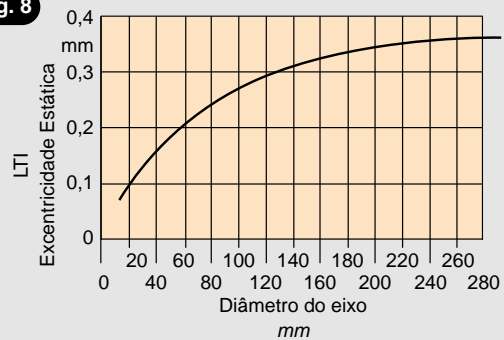

Fig. 9

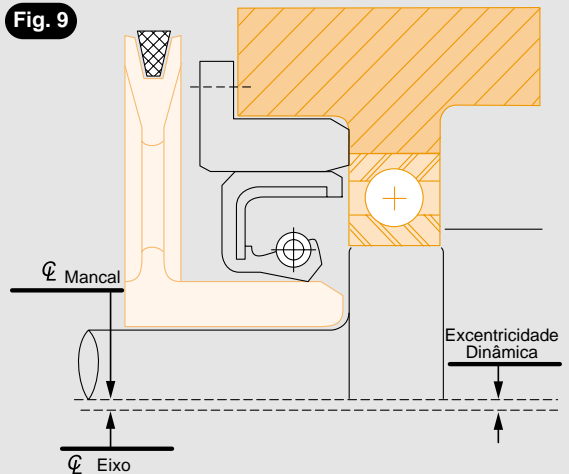
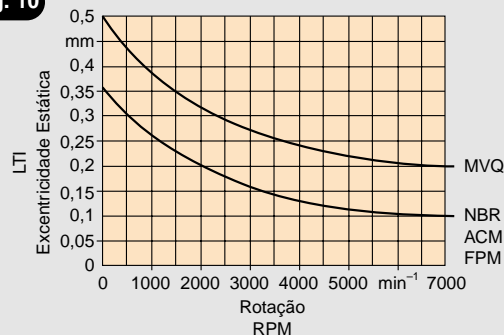

Fig. 10



Recomendações quanto às condições de montagem

1 – Cuidados no armazenamento:

Durante o período de armazenamento, os retentores deverão ser mantidos na própria embalagem Sabó, estocados em local limpo e de forma apropriada, com temperaturas médias recomendadas entre 10 a 40 °C, livre de contaminações e manipulações desnecessárias que possam provocar deformações ou danificações.

2 – Cuidados na manipulação do retentor:

Ao ser desembalado para a montagem, recomenda-se todo cuidado possível para não tocar desnecessariamente no lábio de vedação, de modo a não introduzir deformações, danificações ou deposição de elementos estranhos na aresta de vedação que possam comprometer o bom desempenho na aplicação.

3 – Cuidados na pré-lubrificação do retentor:

Para garantir uma instalação perfeita do retentor no furo do alojamento e também para propiciar a lubrificação inicial da aresta de vedação, por ocasião dos primeiros giros no funcionamento do agregado, recomenda-se pré-lubrificar o lábio do retentor, no próprio fluido da aplicação, mantendo-o em recipiente apropriado e perfeitamente protegido de contaminações externas.

4 – Montagem do retentor no alojamento:

A prensagem do retentor na sede deverá ser feita mediante o uso de uma prensa mecânica ou hidráulica, utilizando-se dispositivos apropriados que atendam as seguintes recomendações:

- Deve-se garantir uma perfeita pré-centralização do retentor, de modo que o mesmo seja prensado na posição correta no alojamento.
- A superfície de apoio no dispositivo do retentor deverá estar o mais próximo possível do diâmetro externo do retentor, de modo a evitar deformações no ato da prensagem.
- De forma alguma o dispositivo deve danificar o lábio de vedação.

Na figura 11 estão ilustrados alguns tipos de dispositivos usualmente empregados.

Fig. 11

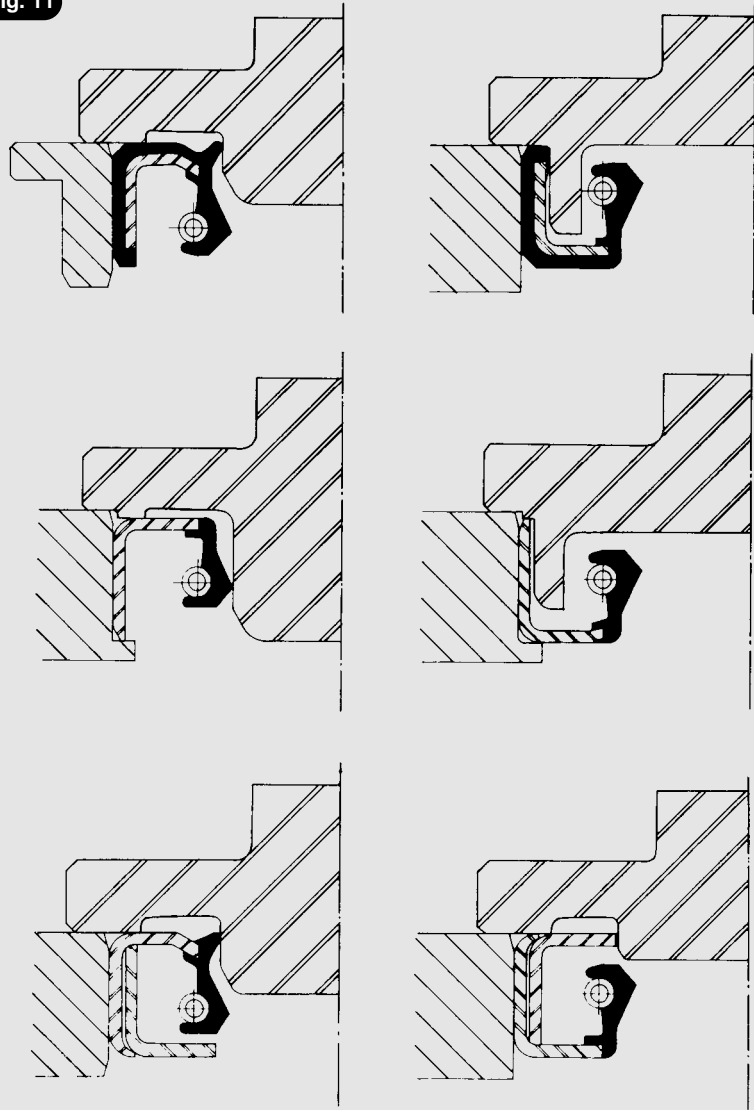

5 – Montagem do retentor no eixo de trabalho:

Não havendo possibilidade de chanfrar ou arredondar as superfícies do eixo sobre as quais deve ser introduzido o retentor, ou então, no caso do retentor ter que passar obrigatoriamente por uma região irregular, como entalhados ou rasgos de chaveta, recomenda-se o uso de uma luva de proteção para o lábio, conforme ilustrado na figura 12, observando que o diâmetro da luva não deforme o lábio.

É de extrema importância que estas luvas estejam com as superfícies externas, por onde passa o lábio do retentor, bem polidas, perfeitamente limpas e livres de danificações ou arestas vivas, provocadas por batidas durante o seu manuseio constante.

6 – Cuidados na substituição do retentor:

Em princípio, sempre que houver a desmontagem de um agregado, por qualquer motivo que implique na desmontagem do retentor ou do eixo de trabalho após o uso, recomenda-se a reposição do retentor por um novo.

Quando a substituição do eixo não for possível, a aresta de vedação do novo retentor não deverá trabalhar na mesma pista deixada pelo retentor anterior. Sempre dever-se-á montá-lo deslocado para o lado interior, observando-se que o eixo esteja em perfeitas condições, livres de defeitos, deposições sólidas ou oxidação.

Não lixar a superfície do eixo.

Muitas vezes, devido ao estado da superfície do furo do alojamento, é inevitável o uso de massa de vedação no externo do retentor para garantir a estanqueidade através do furo do alojamento.

Nestes casos deve-se tomar cuidado para que essa massa de vedação não atinja o lábio de vedação ou o eixo de trabalho, pois, em tais casos, poderá impedir o bom desempenho do retentor e acarretar vazamento.

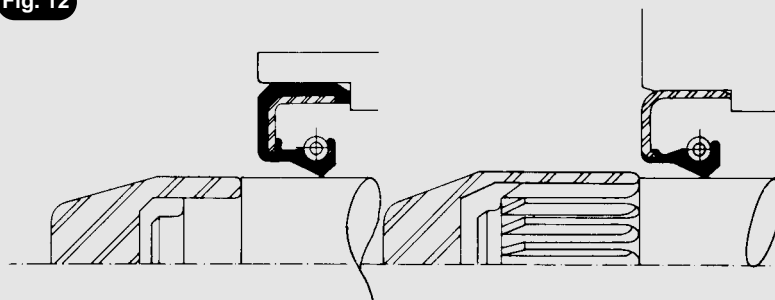
Fig. 12

Normalização de medidas dos retentores segundo a norma DIN 3761

Na figura 13 estão indicadas as medidas do diâmetro do eixo, diâmetro nominal do alojamento e altura dos retentores recomendados pela Norma DIN 3761.

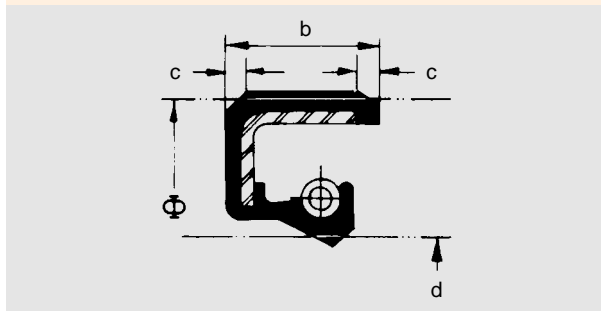

Fig. 13

Diametro do eixo d	Φ	b	c min.
6	16	7	0.3
	22		
7	22	7	0.3
	22		
8	24	7	0.3
	22		
9	24	7	0.3
	26		
10	22	7	0.3
	24		
11	22	7	0.3
	26		
12	22	7	0.3
	24		
	28		
	30		
14	24	7	0.3
	28		
	30		
15	26	7	0.3
	30		
	32		
	35		
16	28	7	0.3
	30		
	32		
17	28	7	0.3
	30		
	32		
	35		
18	30	7	0.3
	32		
	35		
20	30	7	0.3
	32		
	35		
22	30	7	0.3
	32		
	35		
	40		
24	35	7	0.3
	37		
	40		
25	35	7	0.3
	40		
	42		
	47		
26	37	7	0.3
	42		
	47		
28	40	7	0.4
	47		
	52		

Diametro do eixo d	Φ	b	c min.
30	40	7	0.4
	42		
	47		
	52		
32	45	7	0.4
	47		
	52		
	47		
35	50	7	0.4
	52		
	62		
36	47	7	0.4
	50		
	52		
	62		
38	52	7	0.4
	55		
	62		
40	52	7	0.4
	55		
	62		
	72		
42	55	8	0.4
	62		
45	62	8	0.4
	65		
	72		
	60		
48	62	8	0.4
	72		
50	65	8	0.4
	68		
	72		
52	68	8	0.4
	72		
	70		
55	72	8	0.4
	80		
	85		
	70		
56	72	8	0.4
	80		
	85		
	72		
58	80	8	0.4
	75		
60	80	8	0.4
	85		
	90		
	85		
62	85	10	0.5
	90		
63	85	10	0.5
	90		
65	85	10	0.5
	90		
	100		
68	90	10	0.5
	100		

Diametro do eixo d	Φ	b	c min.
70	90	10	0.5
	100		
72	95	10	0.5
	100		
75	95	10	0.5
	100		
78	100	10	0.5
	100		
80	100	10	0.5
	110		
85	110	12	0.8
	120		
90	110	12	0.8
	120		
95	120	12	0.8
	125		
100	120	12	0.8
	125		
	130		
105	130	12	0.8
	140		
110	130	12	0.8
	140		
115	140	12	0.8
	150		
120	150	12	0.8
	160		
125	150	12	0.8
	160		
130	160	12	0.8
	170		
135	170	12	0.8
	170		
140	170	15	1
	175		
145	175	15	1
	180		
150	180	15	1
	190		
160	190	15	1
	200		
170	200	15	1
	210		
180	210	15	1
	220		
190	220	15	1
	230		
200	230	15	1
	240		
210	240	15	1
	250		
220	250	15	1
	260		
230	260	15	1
	270		
240	270	15	1
	280		
250	280	15	1
	300		
260	300	20	1
	320		
280	320	20	1
	340		
300	340	20	1
	360		
320	360	20	1
	380		
340	380	20	1
	400		
360	400	20	1
	420		
380	420	20	1
	440		
400	440	20	1
	460		
420	460	20	1
	480		
440	480	20	1
	500		
460	500	20	1
	520		
480	520	20	1
	540		
500	540	20	1

1) Tolerâncias permissíveis para Φ, vide fig. 6

Conceitos básicos de construção

1. Membrana elastomérica (ou lábio)

- 1.a. Ângulo de ar
- 1.b. Aresta de vedação
- 1.c. Ângulo de óleo
- 1.d. Região de cobertura da mola
- 1.e. Alojamento de mola
- 1.f. Região interna do lábio
- 1.g. Região de engaste do lábio

2. Mola de tração

3. Região interna do vedador, eventualmente recoberta por material elastomérico.

4. Anel de reforço metálico ou carcaça.

- 4.a. Porção cilíndrica de sustentação
- 4.b. Flange radial de engaste

5. Cobertura externa elastomérica

- 5.a. Borda
- 5.b. Chanfro da borda
- 5.c. Superfície cilíndrica externa ou diâmetro externo
- 5.d. Chanfro das costas
- 5.e. Costas

6. Filetes de escoamento de moldagem

7. Carcaça externa metálica

8. Vedação auxiliar

9. Carcaça interna metálica

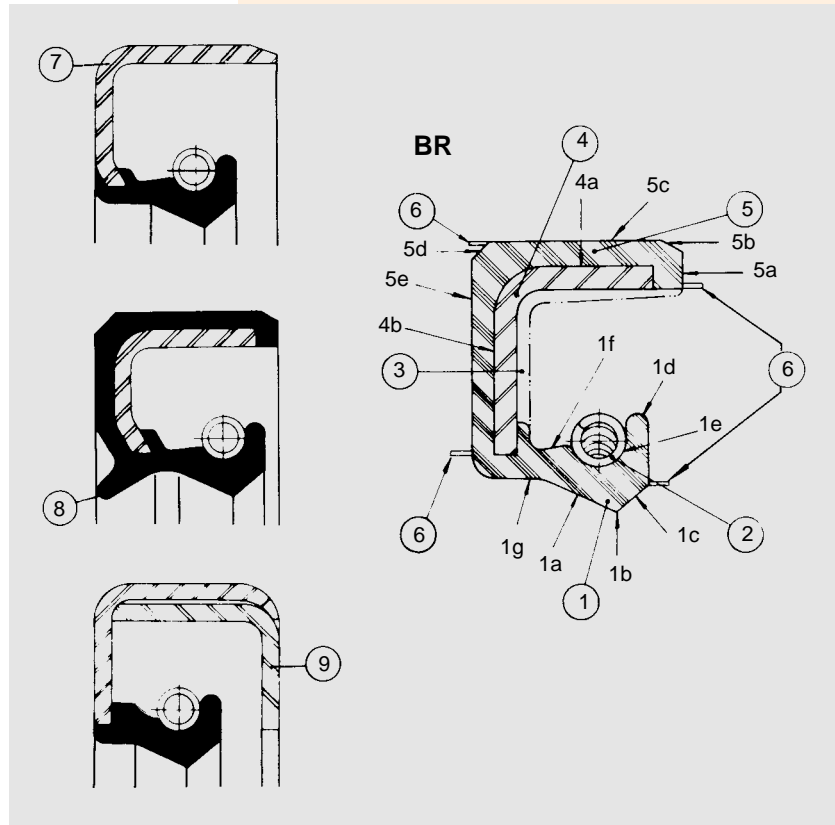

Diâmetro do Eixo	Diâmetro do Alojamento	Altura do Retentor	Número Sabó	Tipo	Orientação	Material do Lábio
5,0	14,50	4,5	03254	BR	LI	NBR
6,0	10,00	2,5	02515	GR	LI	CR
6,0	16,00	6,5	02873	BRG	LI	NBR
6,4	16,05	6,4	00807	BA	LI	NBR
6,4	19,10	6,4	01685	BR	LI	NBR
6,5	14,50	7,0	02306	BRG	LI	NBR
7,0	16,00	7,0	02358	BA	LI	NBR
7,7	14,65	5,0	07078	BR	LI	HNBR
7,8	13,80	3,6	02198	GR	LI	NBR
7,8	14,10	3,6	01984	GA	LI	NBR
7,8	14,60	4,8	00482	GAF	LI	FPM
8,0	14,00	3,0	02495	BRF	LI	FPM
8,0	14,00	3,0	02536	BR	LI	NBR
8,0	15,00	3,0	02491	GR	LI	NBR
8,0	15,00	5,5	02762	BR	LI	NBR
8,0	16,00	7,0	02013	BAP	H	ACM
8,0	17,45	8,0	00198	BA	LI	NBR
8,0	18,00	5,0	01423	BR	LI	NBR
8,0	18,00	5,0	02163	BRG	LI	NBR
8,0	22,00	8,0	01587	BR	LI	NBR
8,5	16,00	6,5	00998	BR	H	NBR
9,4	21,40	5,0	02248	GA	LI	NBR
9,5	19,05	7,0	01853	BR	H	NBR
9,5	19,20	7,0	01093	BR	LI	NBR
9,5	25,35	9,5	00089	B	LI	NBR
10,0	14,00	3,0	02135	GA	LI	NBR
10,0	19,00	6,5	02171	BR	LI	NBR
10,0	21,00	5,0	03005	BR	AH	NBR
10,0	22,00	7,0	01672	BR	LI	NBR
10,0	22,00	7,0	01904	BRP	H	ACM
10,0	22,00	7,0	02160	BR	AH	NBR
10,0	30,00	7,0	00764	BA	LI	NBR
10,3	16,00	4,0	02001	GA	LI	NBR
10,8	22,20	5,4	01067	BR	LI	NBR
11,0	17,00	4,0	01737	BR	LI	NBR
11,0	17,00	4,0	02523	BRF	LI	FPM
11,1	22,20	6,5	02474	BRG	LI	NBR
11,1	25,40	6,0	01479	BR	LI	NBR
11,6	24,00	10,0	07408	BRGP	LI	ACM
12,0	18,00	3,0	02638	GR	LI	NBR
12,0	19,00	5,0	05148	BR	BI	NBR
12,0	20,00	5,0	02689	BAG	LI	NBR
12,0	21,00	4,0	03255	BR	LI	NBR
12,0	22,00	5,0	02535	BRG	LI	NBR
12,0	22,00	7,0	00289	BA	LI	NBR
12,0	28,05	8,0	02792	BAG	LI	NBR
12,0	28,10	7,0	01420	BR	LI	NBR
12,0	32,00	7,0	01445	BA	LI	NBR
12,5	20,00	5,0	02360	BRF	BI	FPM
12,5	25,00	8,0	03250	BRG	LI	NBR
12,6	21,40	5,0	02249	GA	LI	NBR
12,7	22,20	8,0	01559	BR	LI	NBR
12,7	22,20	8,0	02343	BAP	LI	ACM

Diâmetro do Eixo	Diâmetro do Alojamento	Altura do Retentor	Número Sabó	Tipo	Orientação	Material do Lábio
12,7	25,30	9,5	01508	B	LI	NBR
12,7	25,35	6,4	00981	GA	LI	NBR
12,7	25,35	6,4	01966	BA	BI	NBR
12,7	25,40	9,5	00129	BR	LI	NBR
12,7	28,50	9,5	00311	B	LI	NBR
12,7	28,55	6,5	01957	BA	BI	NBR
12,7	30,00	8,0	01097	BR	LI	NBR
13,0	26,00	7,0	02373	BRG	LI	NBR
13,0	26,00	9,0	01074	BRG	LI	NBR
14,0	20,00	3,5	02025	BA	LI	NBR
14,0	22,00	4,0	02569	BRGP	LI	ACM
14,0	22,00	5,0	03252	BRG	BI	NBR
14,0	23,90	6,0	01717	GA	LI	NBR
14,0	24,00	6,0	02162	BRG	LI	NBR
14,0	24,00	7,0	01389	BAG	LI	NBR
14,0	28,00	7,0	02308	BRG	LI	NBR
14,0	32,00	10,0	01875	BR	LI	NBR
14,3	22,00	3,9	01977	GR	LI	NBR
14,3	23,95	7,0	01835	BR	LI	NBR
14,3	25,40	9,5	00716	B	LI	NBR
14,3	28,50	6,4	00293	BR	LI	NBR
14,3	28,50	9,5	00541	B	LI	NBR
14,3	39,55	6,3	02334	BAG	LI	NBR
15,0	21,00	3,0	02589	GR	LI	NBR
15,0	21,00	4,0	02130	BAG	LI	NBR
15,0	21,00	5,0	07397	BRAGP	LI	ACM
15,0	23,00	3,0	02639	GR	LI	NBR
15,0	24,00	7,0	00790	BR	LI	NBR
15,0	24,00	7,0	01929	BRG	LI	NBR
15,0	24,00	7,4	01816	BA	AH	NBR
15,0	25,00	7,0	02309	BRP	AH	ACM
15,0	25,00	7,0	02454	BRG	LI	NBR
15,0	26,00	6,0	02279	BAG	LI	NBR
15,0	28,00	7,0	00916	BA	LI	NBR
15,0	28,55	8,0	01076	B	LI	NBR
15,0	30,00	5,0	00515	GA	LI	NBR
15,0	30,00	6,0	01915	BAGP	LI	ACM
15,0	30,00	7,0	01677	BR	LI	NBR
15,0	30,00	7,0	01846	BAG	LI	NBR
15,0	30,00	8,0	00766	BA	LI	NBR
15,0	30,00	10,0	01348	BR	LI	NBR
15,0	32,00	7,0	01907	BR	LI	NBR
15,0	35,00	7,0	01058	BR	LI	NBR
15,0	35,00	7,0	01959	BAG	LI	NBR
15,0	35,10	10,0	01051	BR	LI	NBR
15,9	22,20	4,3	02335	BAG	LI	NBR
15,9	23,80	4,8	00119	GA	LI	NBR
15,9	25,35	6,4	01175	BA	LI	NBR
15,9	25,40	4,5	00286	BR	LI	NBR
15,9	28,50	7,0	01493	BR	LI	NBR
15,9	28,55	9,5	00156	B	LI	NBR
15,9	30,00	6,0	01934	BAG	H	NBR
15,9	30,30	4,5	01700	GR	LI	NBR

Diâmetro do Eixo	Diâmetro do Alojamento	Altura do Retentor	Número Sabó	Tipo	Orientação	Material do Lábio
15,9	35,00	10,0	00375	BA	LI	NBR
16,0	22,00	3,0	02492	GR	LI	NBR
16,0	22,10	6,4	01576	BAG	LI	NBR
16,0	24,00	6,0	02176	BRG	LI	NBR
16,0	28,00	7,0	00980	BA	LI	NBR
16,0	28,00	7,0	02310	BRG	LI	NBR
16,0	30,00	6,4	01817	BA	AH	NBR
16,0	30,00	10,0	00795	BR	LI	NBR
16,0	32,00	7,0	00796	BR	LI	NBR
16,3	24,00	7,0	00726	BR	LI	NBR
17,0	25,00	3,0	02640	GR	LI	NBR
17,0	25,00	4,0	02161	BR	LI	NBR
17,0	25,00	4,0	02571	BRG	LI	NBR
17,0	25,00	4,0	02669	GA	LI	NBR
17,0	27,00	5,0	03253	BRG	LI	NBR
17,0	28,00	5,0	02701	BRG	LI	NBR
17,0	28,00	6,0	01072	BA	LI	NBR
17,0	28,00	6,0	01072	BR	LI	NBR
17,0	28,00	7,0	00508	BA	LI	NBR
17,0	28,00	7,0	00508	BAG	LI	NBR
17,0	28,00	7,0	03012	BA	LI	NBR
17,0	28,00	7,0	05141	BRA	LI	NBR
17,0	28,05	5,0	02375	BR	LI	NBR
17,0	29,00	5,4	07409	BRP	AH	ACM
17,0	30,00	7,0	02730	BRG	LI	NBR
17,0	31,20	7,5	01464	BA	LI	NBR
17,0	32,00	7,0	01725	BR	LI	NBR
17,0	32,00	7,0	02425	BR	LI	NBR
17,0	34,00	7,0	01916	BAGP	LI	ACM
17,0	35,00	7,0	00853	BR	LI	NBR
17,0	35,00	8,0	01511	BR	LI	NBR
17,0	35,00	10,0	00828	BR	LI	NBR
17,0	35,00	10,0	01415	BRG	LI	NBR
17,0	35,30	7,0	01113	BRG	LI	NBR
17,0	40,00	8,5	01492	BR	LI	NBR
17,5	28,30	7,0	01496	BR	LI	NBR
17,5	30,30	4,5	01871	GR	LI	NBR
17,8	35,00	9,5	00608	B	LI	NBR
18,0	24,00	3,0	02510	GA	LI	NBR
18,0	24,00	4,0	02567	GR	LI	NBR
18,0	24,00	4,0	02698	GR	LI	NBR
18,0	30,00	7,0	00496	BRG	LI	NBR
18,0	30,00	7,0	02329	BRG	LI	NBR
18,0	35,00	10,0	01769	BR	LI	NBR
18,0	37,00	8,0	02164	BRG	LI	NBR
18,0	40,00	9,0	01107	BR	LI	NBR
18,0	47,00	8,0	01400	BR	LI	NBR
18,2	30,00	6,0	02830	BRG	LI	NBR
18,7	34,90	8,7	00745	BGO	LI	NBR
18,8	31,70	11,0	02203	BAG	LI	NBR
19,0	25,40	3,2	00888	GA	LI	NBR
19,0	28,50	4,0	01868	GA	LI	NBR
19,0	28,50	6,4	00329	BA	LI	NBR

Diâmetro do Eixo	Diâmetro do Alojamento	Altura do Retentor	Número Sabó	Tipo	Orientação	Material do Lábio
19,0	28,55	6,5	02131	BAG	LI	NBR
19,0	28,65	4,7	01455	BA	LI	NBR
19,0	29,10	6,4	01909	BR	LI	NBR
19,0	30,10	7,5	01527	BA	LI	NBR
19,0	31,60	7,7	02263	BR	LI	NBR
19,0	31,70	6,4	00569	B	LI	NBR
19,0	31,70	6,4	00569	BR	LI	NBR
19,0	31,75	8,0	00989	BAG	LI	NBR
19,0	31,80	6,4	00821	BR	LI	NBR
19,0	31,85	9,5	00338	BGO	LI	NBR
19,0	31,90	7,0	00798	BA	LI	NBR
19,0	34,90	9,5	00959	B	LI	NBR
19,0	34,95	10,3	01965	BAP	BI	ACM
19,0	35,00	7,0	00784	BR	LI	NBR
19,0	35,00	10,0	00159	BR	LI	NBR
19,0	36,05	8,5	01407	BR	LI	NBR
19,0	36,30	8,5	02722	BR	LI	NBR
19,0	38,05	10,0	00158	B	LI	NBR
19,0	41,25	8,0	00714	BA	LI	NBR
19,0	41,30	11,0	01465	BA	LI	NBR
19,0	42,10	7,0	01235	BR	LI	NBR
19,3	29,10	6,4	01110	BR	LI	NBR
19,9	35,00	7,0	01894	BRG	LI	NBR
20,0	26,00	4,0	02573	GR	LI	NBR
20,0	28,00	4,0	02641	GR	LI	NBR
20,0	30,00	7,0	00505	BR	LI	NBR
20,0	30,00	7,0	01935	BAG	LI	NBR
20,0	31,00	7,0	02285	BA	LI	NBR
20,0	31,00	7,0	03013	BA	LI	NBR
20,0	31,00	7,0	05142	BRA	LI	NBR
20,0	31,20	7,5	01328	BA	H	NBR
20,0	31,95	5,0	00767	BA	LI	NBR
20,0	32,00	6,0	00712	BR	LI	NBR
20,0	32,10	7,0	00953	BR	LI	NBR
20,0	34,00	7,0	02311	BR	AH	NBR
20,0	34,05	7,0	01718	BR	LI	NBR
20,0	34,95	6,0	00715	BA	LI	NBR
20,0	34,95	7,0	02486	BR	LI	NBR
20,0	35,00	4,5	01777	GA	LI	NBR
20,0	35,00	6,0	02821	BRG	LI	NBR
20,0	35,00	8,0	01386	BRG	LI	NBR
20,0	35,00	10,0	00760	BR	LI	NBR
20,0	35,10	4,0	01404	BR	LI	NBR
20,0	35,10	5,8	01866	GR	LI	NBR
20,0	36,00	10,0	00918	BR	LI	NBR
20,0	38,00	6,0	03004	BRG	AH	NBR
20,0	38,05	6,4	02072	BAP	LI	ACM
20,0	38,10	10,0	01189	BR	LI	NBR
20,0	39,70	6,5	02433	BRG	LI	NBR
20,0	39,96	6,4	03126	BRG	LI	NBR
20,0	40,00	4,0	01694	BA	LI	NBR
20,0	40,00	4,0	01694	BAP	LI	ACM
20,0	40,00	6,0	01245	BR	LI	NBR

Diâmetro do Eixo	Diâmetro do Alojamento	Altura do Retentor	Número Sabó	Tipo	Orientação	Material do Lábio
20,0	40,00	7,0	00994	BA	LI	NBR
20,0	40,00	7,0	00994	BRG	LI	NBR
20,0	40,00	7,0	02468	BRG	LI	NBR
20,0	40,00	7,0	02566	BRGF	AH	FPM
20,0	40,00	10,00	00360	BA	LI	NBR
20,0	40,30	10,0	00922	BR	LI	NBR
20,0	42,00	10,0	01746	B	LI	NBR
20,0	47,10	10,0	00909	BR	LI	NBR
20,5	41,20	5,0	00963	BAG	LI	NBR
20,6	38,10	7,0	02480	BAGP	LI	ACM
20,7	34,85	11,9	01254	BAG	LI	NBR
21,0	31,95	7,0	01985	BR	LI	NBR
21,0	32,00	7,0	01883	BAG	LI	NBR
21,0	32,00	7,5	02371	BAG	H	NBR
21,0	32,00	7,5	02371	BAG	H	NBR
21,5	40,00	7,0	02418	BR	H	ACM
21,5	40,00	7,0	07286	BR	H	MVQ
21,8	25,00	1,9	02073	GA	LI	NBR
21,8	35,00	7,0	02740	BRGP	H	ACM
21,8	36,50	6,4	01967	BAS	BI	MVQ
21,9	32,00	6,0	02729	BA	LI	NBR
21,9	32,00	6,0	02729	BA	LI	NBR
22,0	31,85	5,0	00769	BA	LI	NBR
22,0	32,00	5,5	01727	BR	LI	NBR
22,0	32,00	5,5	01727	BR	LI	NBR
22,0	32,00	7,0	01554	BRG	LI	NBR
22,0	35,00	6,7	00294	BR	LI	NBR
22,0	35,00	7,0	01716	BR	LI	NBR
22,0	35,00	7,0	02533	BRGP	AH	ACM
22,0	35,00	7,0	02572	BRG	LI	NBR
22,0	35,00	7,0	02579	BRG	LI	NBR
22,0	35,00	9,0	00955	BAG	LI	NBR
22,0	35,00	10,0	00118	BAG	LI	NBR
22,0	38,05	8,0	01112	BR	LI	NBR
22,0	40,00	7,0	00761	BR	LI	NBR
22,0	40,00	8,0	00992	BRG	LI	NBR
22,0	40,00	8,0	02009	BP	H	ACM
22,0	41,25	8,0	01481	BA	AH	NBR
22,0	42,00	10,0	00815	BR	LI	NBR
22,0	42,00	10,0	01914	BRP	LI	ACM
22,0	47,00	9,0	01779	B	LI	NBR
22,1	35,00	8,0	02126	GA	LI	PU
22,2	28,58	3,2	02715	GA	LI	NBR
22,2	31,00	6,0	02878	BAG	AH	NBR
22,2	31,70	6,0	02357	BA	AH	NBR
22,2	33,15	10,3	00150	BA	LI	NBR
22,2	34,85	8,0	00937	BAG	LI	NBR
22,2	34,95	8,0	00937	B	LI	NBR
22,2	34,95	8,0	00937	BG	LI	NBR
22,2	35,00	8,0	01819	BA	AH	NBR
22,2	38,10	9,5	00100	B	LI	NBR
22,2	50,80	11,1	02064	BAG	LI	NBR
22,3	34,95	6,4	00572	BR	LI	NBR

Diâmetro do Eixo	Diâmetro do Alojamento	Altura do Retentor	Número Sabó	Tipo	Orientação	Material do Lábio
22,8	40,00	8,0	07309	BRAGP	H	ACM
23,0	35,00	8,0	02372	BAG	H	NBR
23,0	35,00	8,0	02837	BRAGF	H	FPM
23,3	59,95	6,4	01613	GA	LI	NBR
23,8	34,50	7,0	02029	BR	LI	NBR
23,8	38,05	6,5	02465	BAG	LI	NBR
23,8	38,05	7,9	01836	B	LI	NBR
23,8	39,00	6,2	01867	GR	LI	NBR
24,0	35,00	6,0	02594	BRF	H	FPM
24,0	36,00	6,0	01666	BR	LI	NBR
24,0	37,00	7,0	01214	BR	LI	NBR
24,0	37,00	7,0	02210	BRG	LI	NBR
24,0	38,00	9,0	00829	BR	LI	NBR
24,0	40,10	10,0	01341	BR	LI	NBR
24,0	42,00	10,0	01507	BR	LI	NBR
24,0	47,00	7,0	00763	BR	LI	NBR
24,6	39,90	8,0	01712	BAG	LI	NBR
25,0	32,00	4,0	02265	GA	LI	NBR
25,0	32,00	4,0	02588	GR	LI	NBR
25,0	32,00	4,0	02642	GR	LI	NBR
25,0	35,00	5,0	02107	GA	LI	NBR
25,0	35,00	7,0	01543	BA	LI	NBR
25,0	35,00	7,0	01543	BR	LI	NBR
25,0	35,00	7,0	02802	BRGF	LI	FPM
25,0	35,00	7,0	05050	BRG	H	NBR
25,0	35,00	7,5	02007	BAGP	BI	ACM
25,0	35,00	8,0	02414	BRG	H	NBR
25,0	35,00	10,0	00788	BAG	LI	NBR
25,0	36,00	7,0	01515	BR	LI	NBR
25,0	37,10	7,3	01577	BR	LI	NBR
25,0	37,90	7,0	01892	BRG	LI	NBR
25,0	38,00	6,4	01019	BR	LI	NBR
25,0	38,00	8,0	01118	B	LI	NBR
25,0	40,00	5,0	01295	GR	LI	NBR
25,0	40,00	7,0	02062	BA	LI	NBR
25,0	40,00	7,0	02570	BRGF	H	FPM
25,0	40,00	8,0	01556	BR	LI	NBR
25,0	40,00	8,0	02233	BRG	BI	NBR
25,0	40,00	8,0	02712	BRGP	H	ACM
25,0	40,00	9,0	02148	BRG	LI	NBR
25,0	40,00	10,0	00469	B	LI	NBR
25,0	41,10	9,5	00191	BR	LI	NBR
25,0	42,00	6,0	01604	BR	LI	NBR
25,0	42,00	8,0	00925	BA	LI	NBR
25,0	43,05	10,0	00506	BR	LI	NBR
25,0	44,90	5,0	00709	BR	LI	NBR
25,0	44,95	7,0	01397	BA	LI	NBR
25,0	47,00	7,0	02010	BAG	LI	NBR
25,0	47,00	7,0	02010	BRO	LI	NBR
25,0	47,00	10,0	00266	BR	LI	NBR
25,0	47,00	10,0	02046	BRG	LI	NBR
25,0	50,10	10,0	00499	BR	LI	NBR
25,0	52,00	8,0	02727	BRG	LI	NBR

Diâmetro do Eixo	Diâmetro do Alojamento	Altura do Retentor	Número Sabó	Tipo	Orientação	Material do Lábio
25,0	52,00	10,0	00463	BR	LI	NBR
25,0	62,00	10,0	00770	B	LI	NBR
25,4	34,80	5,0	01405	GA	LI	NBR
25,4	34,90	6,4	00448	BA	LI	NBR
25,4	34,95	6,4	02032	BA	H	NBR
25,4	36,40	6,4	00283	BR	LI	NBR
25,4	38,00	6,5	02230	B	LI	NBR
25,4	38,00	8,0	00768	B	LI	NBR
25,4	38,00	8,0	00768	BGO	LI	NBR
25,4	38,00	9,5	01327	BAG	LI	NBR
25,4	38,05	8,0	02172	BG	LI	NBR
25,4	38,05	10,0	00141	BA	LI	NBR
25,4	38,10	6,3	01356	BAG	LI	NBR
25,4	41,25	9,5	00934	B	LI	NBR
25,4	44,45	8,3	00844	B	LI	NBR
25,4	44,50	6,5	02527	BAGP	BI	ACM
25,4	44,60	5,0	01156	GR	LI	NBR
25,4	44,60	6,4	01009	BR	LI	NBR
25,4	46,45	9,5	00145	B	LI	NBR
25,4	47,55	11,1	01302	B	LI	NBR
25,4	50,70	10,2	01393	BA	LI	NBR
25,4	50,75	15,8	01547	BGO	LI	NBR
26,0	31,00	3,0	01830	GA	LI	NBR
26,0	35,00	7,0	02568	BRG	LI	NBR
26,0	37,00	7,0	01045	BRG	LI	NBR
26,0	40,00	5,0	01778	GR	LI	NBR
26,0	40,00	8,0	02412	BRG	H	NBR
26,0	42,00	8,0	02525	BRAGF	H	FPM
26,0	42,00	10,0	01151	BRG	LI	NBR
26,0	43,00	10,0	00785	BA	LI	NBR
26,0	45,00	10,0	01860	BA	LI	NBR
26,3	33,30	3,2	01683	GA	LI	NBR
26,8	29,95	1,9	01785	GA	LI	NBR
27,0	33,95	3,0	02691	GA	LI	NBR
27,0	38,10	6,4	00285	BA	LI	NBR
27,0	38,10	6,4	01993	BR	AH	NBR
27,0	40,00	7,0	01751	BRG	LI	NBR
27,0	41,80	7,1	00121	BA	LI	NBR
27,0	42,00	10,0	01625	BR	LI	NBR
28,0	34,90	5,0	00713	GA	LI	NBR
28,0	38,00	6,5	01886	GR	LI	NBR
28,0	40,00	5,0	02106	GA	LI	NBR
28,0	40,00	7,0	01495	BR	LI	NBR
28,0	40,00	7,0	01495	BRF	LI	FPM
28,0	40,00	7,0	01495	BRS	LI	MVQ
28,0	40,00	8,0	02413	BRG	H	NBR
28,0	40,00	8,0	02519	BRG	LI	NBR
28,0	42,00	7,0	01580	B	LI	NBR
28,0	42,00	7,0	02145	BRG	LI	NBR
28,0	47,00	10,0	00262	B	LI	NBR
28,0	47,00	10,0	00262	BA	LI	NBR
28,0	47,50	9,5	00947	BR	LI	NBR
28,0	50,00	12,0	01020	B	LI	NBR

Diâmetro do Eixo	Diâmetro do Alojamento	Altura do Retentor	Número Sabó	Tipo	Orientação	Material do Lábio
28,0	52,10	10,0	00503	BR	LI	NBR
28,2	37,95	6,0	02549	BRP	LI	ACM
28,2	43,00	9,1	00607	B	LI	NBR
28,4	45,00	8,5	01188	BR	LI	NBR
28,5	36,50	7,0	00122	GA	LI	NBR
28,5	38,00	6,0	02828	BR	LI	NBR
28,5	50,70	10,0	00771	BA	LI	NBR
28,6	34,90	3,2	01539	GA	LI	NBR
28,6	38,00	7,0	01022	BR	LI	NBR
28,6	38,06	6,0	01299	BR	LI	NBR
28,6	38,10	6,5	01964	BA	H	NBR
28,6	39,65	6,4	00581	BR	LI	NBR
28,6	39,70	9,5	00054	BR	LI	NBR
28,6	39,70	9,5	02654	BR	LI	NBR
28,6	39,75	4,7	00117	GR	LI	NBR
28,6	39,75	6,4	01998	BR	LI	NBR
28,6	39,75	7,0	00932	BR	LI	NBR
28,6	40,20	5,0	02337	GA	LI	NBR
28,6	41,20	7,0	02731	BAGF	LI	FPM
28,6	41,25	6,5	02355	BA	H	NBR
28,6	41,25	6,5	02877	BAG	H	NBR
28,6	41,30	9,4	01962	BA	AH	NBR
28,6	42,95	6,5	01661	BAG	LI	NBR
28,6	44,50	11,0	00634	BAG	LI	NBR
28,6	46,55	11,3	00056	B	LI	NBR
28,6	50,30	9,5	00950	B	LI	NBR
28,6	52,30	9,5	00961	B	LI	NBR
28,6	57,15	9,5	01635	BR	LI	NBR
28,7	31,78	3,1	02361	GA	LI	NBR
28,7	40,00	7,0	02140	BAP	H	ACM
29,0	50,00	10,0	02244	B	AH	NBR
29,4	42,83	8,0	02153	BRG	LI	NBR
29,4	46,45	10,0	00127	B	LI	NBR
29,9	45,00	7,0	01833	BA	H	NBR
29,9	52,00	8,0	01895	BRG	LI	NBR
29,9	58,10	8,0	02407	BA	BI	NBR
30,0	36,95	3,0	02788	GA	LI	NBR
30,0	37,00	4,0	02643	GR	LI	NBR
30,0	37,10	4,0	02096	BA	LI	NBR
30,0	40,00	7,0	01535	BR	LI	NBR
30,0	40,00	7,0	01903	BRP	LI	ACM
30,0	40,00	8,0	00810	BA	LI	NBR
30,0	42,00	6,0	05117	BRG	BI	NBR
30,0	42,00	7,0	00847	BAG	LI	NBR
30,0	42,00	7,0	05093	BRAGF	H	FPM
30,0	42,00	10,0	02234	BRG	LI	NBR
30,0	42,05	8,0	01667	BR	LI	NBR
30,0	42,95	9,5	00813	BA	LI	NBR
30,0	42,95	9,5	00813	BAG	LI	NBR
30,0	43,00	8,0	05074	BRAGF	H	FPM
30,0	43,60	7,0	07022	BRGP	H	ACM
30,0	44,00	7,0	05530	BRGP	H	ACM
30,0	45,00	12,0	00832	BR	LI	NBR

Diâmetro do Eixo	Diâmetro do Alojamento	Altura do Retentor	Número Sabó	Tipo	Orientação	Material do Lábio
30,0	46,40	10,0	01831	BA	LI	NBR
30,0	47,00	6,0	01695	BR	LI	NBR
30,0	47,00	6,0	02593	BR	AH	NBR
30,0	47,00	7,0	02376	BRG	AH	NBR
30,0	47,00	7,0	02678	BRGS	H	MVQ
30,0	47,00	7,0	05202	BRAGP	H	ACM
30,0	47,00	10,0	00131	BR	LI	NBR
30,0	47,00	10,0	02930	BRGP	BI	ACM
30,0	50,00	10,0	00358	BR	LI	NBR
30,0	50,00	11,0	00911	BRG	LI	NBR
30,0	50,05	12,0	00484	BA	LI	NBR
30,0	50,75	11,0	00701	B	LI	NBR
30,0	52,00	7,0	02006	BAG	H	NBR
30,0	52,00	7,0	05073	BRAGF	H	FPM
30,0	52,00	8,0	00952	BR	LI	NBR
30,0	52,00	8,0	02813	BRG	LI	NBR
30,0	52,00	9,0	01743	BS	LI	MVQ
30,0	52,00	9,0	02401	B	LI	NBR
30,0	52,00	10,0	00949	BR	LI	NBR
30,0	52,00	12,0	00824	B	LI	NBR
30,0	52,00	12,0	01952	BA	AH	NBR
30,0	52,20	7,0	02831	BAGP	H	ACM
30,0	55,00	12,0	00772	BA	LI	NBR
30,0	56,00	12,0	00817	BR	LI	NBR
30,0	58,10	11,0	07299	BA	AH	NBR
30,0	62,00	10,1	01273	BA	LI	NBR
30,0	72,00	9,5	01182	BR	LI	NBR
30,0	72,00	10,0	01581	BGO	LI	NBR
30,2	47,00	8,0	00455	BA	LI	NBR
30,2	62,00	12,0	01063	BA	LI	NBR
30,3	39,65	6,4	01992	BR	H	NBR
31,0	41,00	9,5	00519	BA	LI	NBR
31,0	47,00	7,0	00762	BR	LI	NBR
31,0	50,00	8,0	02317	BRGF	H	FPM
31,7	42,80	7,9	01630	BAG	LI	NBR
31,7	42,85	5,0	00114	GR	LI	NBR
31,7	44,45	7,0	01843	BA	H	NBR
31,7	44,50	6,5	01149	BR	LI	NBR
31,7	44,50	8,0	00343	BR	LI	NBR
31,7	44,50	9,5	01154	B	LI	NBR
31,7	50,30	11,1	01698	B	LI	NBR
31,7	50,70	9,5	00774	B	LI	NBR
31,7	50,70	11,0	00028	B	LI	NBR
31,7	50,80	11,1	02063	BAG	LI	NBR
31,7	51,00	5,0	01703	GR	LI	NBR
31,7	52,30	9,5	01377	B	LI	NBR
31,7	53,95	6,5	02052	BAGP	LI	ACM
31,8	42,80	9,5	00017	B	LI	NBR
31,8	44,45	8,0	02215	BG	LI	NBR
31,8	44,50	6,5	01149	BA	H	NBR
31,8	45,03	3,6	03129	GR	LI	NBR
31,9	44,00	9,0	01370	BA	LI	NBR
32,0	42,00	7,0	01310	BAG	LI	NBR

Diâmetro do Eixo	Diâmetro do Alojamento	Altura do Retentor	Número Sabó	Tipo	Orientação	Material do Lábio
32,0	42,00	7,0/8,0	05159	BRAGF	H	FPM
32,0	43,00	5,0	02144	GR	LI	NBR
32,0	43,00	7,0	01715	BR	LI	NBR
32,0	44,25	9,0	00170	BA	LI	NBR
32,0	45,00	6,0	01726	BR	LI	NBR
32,0	45,00	6,5	02987	GR	LI	NBR
32,0	45,00	7,0	00495	BA	LI	NBR
32,0	45,00	7,0	02397	BRG	AH	NBR
32,0	45,00	7,0	02984	BRG	LI	NBR
32,0	47,00	10,0	01942	BRGP	H	ACM
32,0	47,00	10,0	02142	BRGF	BI	FPM
32,0	47,00	10,0	02842	BRGF	H	FPM
32,0	47,00	10,0	02843	BRGF	AH	FPM
32,0	47,00	10,0	02950	BRGF	BI	FPM
32,0	47,50	6,4	01563	BA	LI	NBR
32,0	48,00	8,0	05529	BRGP	H	ACM
32,0	50,00	8,0	00839	BR	LI	NBR
32,0	51,90	12,0	01353	BRG	LI	NBR
32,0	52,00	7,0	02699	BRG	LI	NBR
32,0	52,00	9,0	01744	B	LI	NBR
32,0	52,10	10,0	00801	BR	LI	NBR
32,0	57,05	9,5	00477	BA	LI	NBR
32,0	65,00	13,0	02184	BAGP	AH	ACM
32,0	72,00	10,0	02270	B	BI	NBR
33,0	45,00	7,0	02012	BRF	LI	FPM
33,0	50,00	6,0	01603	BRG	H	NBR
33,0	50,00	8,0	01839	BA	H	NBR
33,0	51,90	12,0	01849	BAG	BI	NBR
33,0	52,00	6,0	01589	BR	LI	NBR
33,3	46,40	9,5	00322	BA	LI	NBR
33,3	53,95	11,0	02242	BG	H	NBR
33,3	69,40	7,9	01040	BA	LI	NBR
34,0	48,00	7,0	05307	BRGP	H	ACM
34,0	52,00	7,0	07364	BRAGP	H	ACM
34,0	52,00	7,5	01509	BR	LI	NBR
34,0	62,10	10,0	01157	BR	LI	NBR
34,0	63,00	12,0	03251	BRG	LI	NBR
34,5	48,05	8,8	01048	BR	LI	NBR
34,9	50,75	8,3	02221	BA	LI	NBR
34,9	50,85	8,3	02102	BA	H	NBR
34,9	52,00	7,0	02575	BRAGF	BI	FPM
34,9	52,30	9,5	01395	B	LI	NBR
34,9	53,50	6,5	02315	GA	LI	NBR
34,9	55,90	12,5	01844	BAG	AH	NBR
34,9	63,00	13,0	01343	BAG	H	NBR
35,0	42,00	4,0	02095	GA	LI	NBR
35,0	42,00	4,0	02632	GR	LI	NBR
35,0	44,50	7,0	01502	BA	LI	NBR
35,0	45,00	7,0	00822	BA	LI	NBR
35,0	46,45	6,4	01526	BRG	LI	NBR
35,0	46,50	4,8	01152	GR	LI	NBR
35,0	47,00	7,0	00485	BA	LI	NBR
35,0	47,00	7,0	02962	BRGF	BI	FPM

Diâmetro do Eixo	Diâmetro do Alojamento	Altura do Retentor	Número Sabó	Tipo	Orientação	Material do Lábio
35,0	47,05	9,0	00969	BR	LI	NBR
35,0	47,05	10,0	00520	BR	LI	NBR
35,0	47,55	9,5	01041	B	LI	NBR
35,0	48,00	7,0	02178	BRGS	H	MVQ
35,0	48,00	7,0	05003	BRAGS	H	MVQ
35,0	48,00	7,0	05005	BRAGS	H	MVQ
35,0	50,00	7,0	05253	BRGF	H	FPM
35,0	50,00	8,0	00962	BR	H	NBR
35,0	50,00	8,0	00962	BRGP	H	ACM
35,0	50,00	8,0	02456	BRGS	H	MVQ
35,0	50,00	10,0	00789	BA	LI	NBR
35,0	50,00	10,0	00789	BR	LI	NBR
35,0	52,00	12,0	00912	BRG	LI	NBR
35,0	52,10	10,0	01742	BR	LI	NBR
35,0	52,10	12,0	00758	BR	LI	NBR
35,0	52,30	9,5	00879	BR	LI	NBR
35,0	53,90	9,5	00694	B	LI	NBR
35,0	53,95	11,0	00214	BR	LI	NBR
35,0	54,85	11,0	01371	BAG	LI	NBR
35,0	55,00	8,0	01980	BR	LI	NBR
35,0	55,50	6,4	00284	BR	LI	NBR
35,0	56,00	10,0	02087	BAG	BI	NBR
35,0	56,00	10,0	02224	BR	AH	NBR
35,0	56,00	10,0	07399	BRP	AH	ACM
35,0	56,05	12,0	00492	BA	LI	NBR
35,0	57,90	6,4	00258	GA	LI	NBR
35,0	58,00	10,0	01551	BR	LI	NBR
35,0	58,00	10,0	01905	BR	BI	NBR
35,0	60,25	12,7	00009	BR	LI	NBR
35,0	60,30	9,5	02304	BRG	LI	NBR
35,0	61,80	7,5	00026	GA	LI	NBR
35,0	62,00	9,5	00800	BA	LI	NBR
35,0	62,00	10,0	01949	BR	AH	NBR
35,0	62,00	12,0	00136	BA	LI	NBR
35,0	62,00	12,0	02091	BAG	BI	NBR
35,0	63,10	14,0	02303	BRG	LI	NBR
35,0	63,50	12,7	00033	B	LI	NBR
35,0	72,00	10,0	01366	B	LI	NBR
35,0	80,00	6,0	02151	BA	LI	NBR
35,0	80,00	12,0	01954	BR	H	NBR
35,0	82,90	10,0	02732	BRG	BI	NBR
35,5	58,20	13,0	01004	BAG	BI	NBR
36,0	54,00	7,0	00797	BR	LI	NBR
36,0	54,00	7,0	02099	BA	H	NBR
36,0	54,00	7,5	01421	BR	LI	NBR
36,0	56,00	10,0	00615	BR	LI	NBR
36,0	60,00	9,5	01814	BRG	BI	NBR
36,5	57,05	12,7	00218	B	LI	NBR
36,6	41,75	3,0	01882	GA	LI	NBR
36,6	52,35	8,0	05167	BRG	H	MVQ
37,0	47,00	10,2	05363	BRG	H	FPM
37,0	50,00	10,0	01608	BR	LI	NBR
38,0	43,00	3,0	02444	GA	LI	NBR

Diâmetro do Eixo	Diâmetro do Alojamento	Altura do Retentor	Número Sabó	Tipo	Orientação	Material do Lábio
38,0	47,60	6,5	02505	BA	LI	NBR
38,0	50,00	7,0	00486	BA	LI	NBR
38,0	50,35	11,0	02565	BGF	H	FPM
38,0	52,00	10,0	00479	BR	LI	NBR
38,0	52,00	10,0	00479	BRG	LI	NBR
38,0	52,25	6,2	01432	GA	LI	NBR
38,0	52,25	7,0	02506	BR	LI	NBR
38,0	53,05	8,5	01786	BRG	LI	NBR
38,0	54,00	10,0	02051	BR	LI	NBR
38,0	57,00	7,0	01657	BA	LI	NBR
38,0	58,50	7,0	01832	BR	BI	NBR
38,0	62,00	7,0	02128	BA	LI	NBR
38,0	69,95	12,7	01318	B	LI	NBR
38,0	73,95	11,0	01710	BAG	LI	NBR
38,0	74,00	11,0	02289	BAG	H	NBR
38,1	47,60	6,4	01536	BA	LI	NBR
38,1	47,60	7,0	02385	BA	H	NBR
38,1	47,60	7,0	07303	BA	H	NBR
38,1	50,10	7,0	01355	BR	LI	NBR
38,1	50,30	11,1	01284	B	LI	NBR
38,1	50,35	11,0	01803	BAG	LI	NBR
38,1	50,75	5,5	00470	GA	LI	NBR
38,1	50,75	9,5	01659	BA	LI	NBR
38,1	54,10	11,0	00203	BR	LI	NBR
38,1	55,55	6,4	01396	BA	LI	NBR
38,1	60,30	12,7	00049	B	LI	NBR
38,1	60,30	12,7	00049	BAG	AH	NBR
38,1	60,35	12,7	01854	BRG	H	NBR
38,1	63,50	12,7	00019	BR	LI	NBR
38,1	63,55	12,7	02034	BRG	H	NBR
38,2	60,35	12,7	01877	BAG	AH	NBR
38,2	63,50	11,1	00995	BA	BI	NBR
39,1	62,20	6,4	00373	GA	LI	NBR
39,4	62,00	14,0	00066	BAG	AH	NBR
39,4	63,55	12,5	02438	BRG	AH	NBR
39,4	63,55	12,7	02038	BRG	BI	NBR
39,7	57,10	6,4	01869	GA	LI	NBR
39,7	61,20	12,7	00016	B	LI	NBR
39,7	62,00	12,0	00166	BR	LI	NBR
39,7	63,45	12,7	01811	B	LI	NBR
39,7	68,15	11,1	00871	BGO	LI	NBR
40,0	50,00	4,0	01419	GA	LI	NBR
40,0	50,00	4,0	02633	GR	LI	NBR
40,0	52,00	6,0	02822	BRG	LI	NBR
40,0	52,00	7,4	01988	BRG	LI	NBR
40,0	52,00	8,0	02430	BRGF	H	FPM
40,0	52,00	9,0	02068	BRGP	BI	ACM
40,0	55,00	8,0	01707	BRG	LI	NBR
40,0	55,00	8,0	02391	BRG	BI	NBR
40,0	55,00	8,0	02541	BRGP	AH	ACM
40,0	55,00	8,0	02972	BAG	BI	NBR
40,0	55,00	8,0	07021	BRGP	H	ACM
40,0	55,00	8,0	07284	BRAG	BI	NBR

Diâmetro do Eixo	Diâmetro do Alojamento	Altura do Retentor	Número Sabó	Tipo	Orientação	Material do Lábio
40,0	55,00	9,0	01155	B	LI	NBR
40,0	55,00	9,5	02419	BAG	BI	NBR
40,0	55,15	10,0	01745	BR	LI	NBR
40,0	56,00	7,0	02005	BAGP	H	ACM
40,0	56,00	7,0	02031	BR	LI	NBR
40,0	56,00	7,0	02302	BAGF	H	FPM
40,0	56,00	8,0	00880	BR	LI	NBR
40,0	56,00	8,5	01759	GR	LI	NBR
40,0	56,00	9,0	01265	BAG	LI	NBR
40,0	56,00	10,0	01046	BAG	LI	NBR
40,0	56,10	12,0	00265	BR	LI	NBR
40,0	57,00	12,0	00924	BR	LI	NBR
40,0	60,00	10,0	01116	BR	LI	NBR
40,0	60,00	12,0	00897	BR	LI	NBR
40,0	62,00	11,5	01109	BR	LI	NBR
40,0	62,00	11,5	01109	BRG	LI	NBR
40,0	62,00	12,0	02377	BG	LI	NBR
40,0	62,10	10,0	01322	BR	LI	NBR
40,0	65,00	12,0	01266	BAG	LI	NBR
40,0	65,00	12,0	02088	BGO	BI	NBR
40,0	68,00	12,0	02225	BR	AH	NBR
40,0	70,00	12,0	00837	B	LI	NBR
40,0	72,00	12,0	01602	BAG	LI	NBR
40,0	80,10	10,0	00913	BR	LI	NBR
40,0	82,90	10,0	02675	BRG	BI	NBR
40,1	52,00	7,4	01988	BRG	LI	NBR
40,2	52,00	7,0	01491	BA	LI	NBR
40,5	53,95	7,2	01958	BAGS	BI	MVQ
40,8	44,05	3,1	02322	GA	LI	NBR
40,8	44,05	3,2	02521	GA	LI	NBR
41,0	65,40	13,0	07381	BAG	BI	NBR
41,1	49,30	6,5	01963	BAG	H	NBR
41,1	62,00	16,0	00626	BGO	LI	NBR
41,1	62,05	16,0	02027	BGO	H	NBR
41,1	65,40	13,0	01100	BAG	BI	NBR
41,2	63,50	8,0	02084	BAGP	H	ACM
41,2	63,50	8,0	02084	BAP	H	ACM
41,2	63,50	8,0	07062	BAGP	H	ACM
41,3	54,00	6,5	02356	BA	LI	NBR
41,3	54,00	6,5	02879	BAG	BI	NBR
41,3	59,10	8,0	01989	BAG	BI	NBR
41,3	61,80	12,7	01378	B	LI	NBR
41,3	61,90	12,0	00083	B	LI	NBR
41,3	63,55	6,5	02053	BAGP	BI	ACM
41,3	63,55	12,7	00133	BR	LI	NBR
41,3	66,55	12,7	00692	B	LI	NBR
41,3	75,75	6,4	00951	GA	LI	NBR
41,4	70,60	7,9	01931	BAG	LI	NBR
42,0	53,00	7,0	05250	BRGF	H	FPM
42,0	55,00	9,0	02058	BAGF	LI	FPM
42,0	56,00	7,0	00288	BR	LI	NBR
42,0	56,00	7,0	02321	BAG	LI	NBR
42,0	58,00	7,0	02059	BA	LI	NBR

Diâmetro do Eixo	Diâmetro do Alojamento	Altura do Retentor	Número Sabó	Tipo	Orientação	Material do Lábio
42,0	58,00	7,0	02793	BRGF	H	FPM
42,0	58,00	7,0	03164	GRG	LI	NBR
42,0	58,00	7,0	05411	BA	LI	NBR
42,0	60,00	9,0	02296	BRG	AH	NBR
42,0	62,00	6,0	01802	BR	LI	NBR
42,0	62,00	12,0	00361	BA	LI	NBR
42,0	62,10	10,0	00521	BR	LI	NBR
42,0	64,90	12,0	00561	BAG	LI	NBR
42,0	65,00	12,0	01506	BF	LI	FPM
42,0	65,00	13,0	01809	BS	LI	MVQ
42,0	65,05	10,0	01505	BR	LI	NBR
42,0	72,00	10,0	02039	BR	AH	NBR
42,0	72,00	12,0	01081	BR	LI	NBR
42,8	63,35	9,5	00564	BR	LI	NBR
42,8	68,15	10,7	00533	BA	LI	NBR
43,0	52,00	6,5	02979	BA	LI	NBR
43,0	52,00	6,5	02981	GA	LI	NBR
43,0	62,00	10,0	00604	BR	LI	NBR
43,0	75,00	10,0	02658	BRGF	AH	FPM
44,0	58,00	7,0	02295	BA	LI	NBR
44,0	60,00	10,0	01552	BR	LI	NBR
44,0	60,00	10,0	02014	BAGP	AH	ACM
44,0	76,10	12,7	00219	BR	LI	NBR
44,0	79,90	12,0	00775	BA	LI	NBR
44,2	71,45	14,8	01119	BAG	H	NBR
44,3	60,00	7,0	02378	BR	LI	NBR
44,3	81,00	12,5	02196	BR	LI	NBR
44,4	63,50	12,7	02580	BAG	BI	NBR
44,4	63,50	12,7	02784	BAGF	BI	FPM
44,5	54,00	4,8	00749	BA	LI	NBR
44,5	57,15	9,4	00734	BR	LI	NBR
44,5	60,30	9,5	00877	BR	LI	NBR
44,5	61,90	9,5	01859	BAG	H	NBR
44,5	62,00	11,0	01095	BRG	BI	NBR
44,5	63,40	4,8	01306	GR	LI	NBR
44,5	63,50	9,5	01845	BRP	H	ACM
44,5	63,55	8,0	02104	BA	H	NBR
44,5	63,55	12,7	00101	B	LI	NBR
44,5	65,05	8,0	01532	BR	LI	NBR
44,5	66,65	12,7	00128	BR	LI	NBR
44,5	68,15	12,7	00588	B	LI	NBR
44,5	68,20	15,9	01679	BRG	LI	NBR
44,5	68,20	15,9	01679	BRGS	LI	MVQ
44,5	69,80	12,7	00069	B	LI	NBR
44,5	70,00	10,0	01656	BR	LI	NBR
44,5	73,00	12,0	00276	B	LI	NBR
44,5	73,00	12,7	02880	BG	LI	NBR
44,5	79,90	11,1	00554	BA	LI	NBR
44,7	61,20	8,8	05522	BRAGF	H	FPM
44,7	61,20	9,5	00222	BAG	H	NBR
44,8	61,30	12,0	00012	BA	LI	NBR
45,0	51,90	4,0	02736	GA	LI	NBR
45,0	55,00	4,0	02634	GR	LI	NBR

Diâmetro do Eixo	Diâmetro do Alojamento	Altura do Retentor	Número Sabó	Tipo	Orientação	Material do Lábio
45,0	60,00	7,0	00272	BRG	LI	NBR
45,0	60,00	7,0	02745	BRG	LI	NBR
45,0	60,00	8,0	02175	BRGP	BI	ACM
45,0	60,00	8,0	07012	BRGP	BI	ACM
45,0	60,00	9,0	01911	BRG	H	NBR
45,0	60,00	9,0	01911	BRGF	H	FPM
45,0	60,00	10,0	01738	B	LI	NBR
45,0	60,00	10,0	01851	BRG	H	NBR
45,0	62,00	7,0	02169	BA	LI	NBR
45,0	62,00	8,0	01760	GR	LI	NBR
45,0	62,00	9,0	02110	BRG	LI	NBR
45,0	62,00	9,0	02298	BAG	AH	NBR
45,0	62,00	9,0	02720	BRGP	H	ACM
45,0	62,00	10,0	00063	BRG	LI	NBR
45,0	63,95	9,0	01711	BRG	LI	NBR
45,0	64,95	12,0	01344	BR	LI	NBR
45,0	65,00	8,0	02324	BRG	LI	NBR
45,0	65,00	10,0	00359	BR	LI	NBR
45,0	65,00	10,0	07365	BRAGF	H	FPM
45,0	66,20	6,0	01141	BR	LI	NBR
45,0	67,90	12,0	01207	BAG	LI	NBR
45,0	72,00	9,5	01553	BR	LI	NBR
45,0	72,00	10,0	01906	BA	LI	NBR
45,0	72,00	12,0	00509	BR	LI	NBR
45,0	85,00	13,0	01038	B	LI	NBR
45,6	48,75	3,2	02522	GA	LI	NBR
46,0	56,00	4,0	02591	BRG	LI	NBR
46,0	62,00	7,0	00302	B	LI	NBR
46,0	65,50	7,0	01764	BRG	LI	NBR
46,0	68,00	12,0	07599	BAF	H	FPM
46,3	66,60	6,4	00849	BA	LI	NBR
46,7	62,00	9,0	05353	BRGF	H	FPM
47,0	62,10	8,0	01140	BR	LI	NBR
47,5	76,05	9,5	00848	GA	LI	NBR
47,6	57,15	5,0	02558	BAF	H	FPM
47,6	62,70	11,1	00368	BAG	LI	NBR
47,6	63,50	11,0	01955	BAGS	BI	MVQ
47,6	63,55	9,7	02990	BAGP	H	ACM
47,6	66,55	12,7	00405	B	LI	NBR
47,6	69,80	12,7	00155	B	LI	NBR
47,6	69,85	9,5	01699	BR	LI	NBR
47,6	70,55	13,5	01369	BA	LI	NBR
47,6	75,30	6,4	00015	GA	LI	NBR
47,6	79,25	10,0	01519	BR	LI	NBR
47,6	82,80	11,0	01460	B	LI	NBR
47,7	62,10	8,0	00264	BR	LI	NBR
47,7	65,00	8,0	02055	BR	H	NBR
47,7	72,95	12,0	00674	B	LI	NBR
47,8	65,00	11,7	02365	BAG	H	NBR
48,0	62,00	8,0	00566	BA	LI	NBR
48,0	65,00	10,0	00527	B	LI	NBR
48,0	65,00	12,0	01840	BGO	AH	NBR
48,0	65,10	7,0	01147	BRG	LI	NBR

Diâmetro do Eixo	Diâmetro do Alojamento	Altura do Retentor	Número Sabó	Tipo	Orientação	Material do Lábio
48,0	65,50	7,0	02833	BAGG	LI	NBR
48,0	66,00	11,0	02721	BRGP	AH	ACM
48,0	66,10	12,0	01793	BR	LI	NBR
48,0	69,00	10,0	07485	BAF	H	FPM
48,0	72,00	7,0	02139	BRG	LI	NBR
48,0	72,00	10,0	00161	BRG	LI	NBR
48,0	72,00	10,0	01902	BR	H	NBR
48,0	72,10	7,0	00522	BRG	LI	NBR
48,0	75,00	8,0	02723	BAF	H	FPM
49,0	65,00	10,0	01241	BAG	LI	NBR
49,0	68,00	12,0	01262	BAG	LI	NBR
49,0	75,00	11,0	01017	BR	LI	NBR
49,2	63,50	9,5	00157	BA	LI	NBR
49,2	65,00	8,0	00708	BR	LI	NBR
49,2	69,90	9,5	00072	BA	LI	NBR
49,2	76,05	12,7	00291	B	LI	NBR
49,2	76,05	12,7	00291	BR	LI	NBR
49,2	79,35	12,5	01994	BR	H	NBR
49,2	80,90	11,0	00229	B	LI	NBR
50,0	58,00	4,0	01973	GA	LI	NBR
50,0	65,00	8,0	01422	BR	LI	NBR
50,0	65,00	8,5	01783	BRG	LI	NBR
50,0	65,00	10,0	01740	B	LI	NBR
50,0	68,00	8,5	01847	GR	LI	NBR
50,0	68,00	9,0	02108	BRG	LI	NBR
50,0	68,00	10,0	01340	BR	LI	NBR
50,0	69,60	12,7	00653	B	LI	NBR
50,0	70,00	10,0	00946	BR	LI	NBR
50,0	70,00	12,0	01807	BAG	LI	NBR
50,0	71,85	12,0	00162	BR	LI	NBR
50,0	72,00	12,0	01861	BRG	LI	NBR
50,0	72,08	10,0	00834	BR	LI	NBR
50,0	87,00	12,7	01855	BAG	LI	NBR
50,8	65,05	12,7	02262	BAG	LI	NBR
50,8	65,10	12,7	01671	GA	LI	NBR
50,8	69,80	12,7	00468	B	LI	NBR
50,8	69,85	11,0	05308	BRGP	H	ACM
50,8	71,90	11,9	01878	B	LI	NBR
50,8	73,00	12,7	00630	B	LI	NBR
50,8	76,25	12,7	00048	BR	LI	NBR
50,8	79,90	10,0	00752	BA	LI	NBR
50,8	80,00	12,7	00660	B	LI	NBR
50,8	81,00	11,9	00274	BGO	LI	NBR
50,9	69,80	9,5	00586	BRG	H	NBR
51,0	58,00	4,0	02342	GA	LI	NBR
52,0	70,00	8,0	03317	BAGP	BI	ACM
52,0	72,00	12,0	00047	B	LI	NBR
52,0	72,00	12,0	00047	BAGF	LI	FPM
52,0	72,00	12,0	01950	BAG	H	NBR
52,0	80,05	10,0	00867	BR	LI	NBR
52,4	68,00	10,5	01187	BR	LI	NBR
52,4	69,80	12,7	00843	B	LI	NBR
52,4	72,10	11,4	00004	B	LI	NBR

Diâmetro do Eixo	Diâmetro do Alojamento	Altura do Retentor	Número Sabó	Tipo	Orientação	Material do Lábio
52,4	76,10	7,9	00974	BA	LI	NBR
52,4	80,95	11,5	00005	B	LI	NBR
53,0	69,85	11,0	05309	BRGP	H	ACM
53,0	75,00	12,0	00838	B	LI	NBR
53,0	82,00	7,5	07023	GA	LI	NBR
53,8	77,70	12,7	00006	BA	LI	NBR
53,9	73,00	12,7	00037	B	LI	NBR
53,9	76,15	12,7	00093	BA	LI	NBR
53,9	81,10	12,0	00231	BRG	LI	NBR
54,0	65,00	8,0	01278	BA	LI	NBR
54,0	72,00	8,0	00563	BR	LI	NBR
54,0	73,00	9,5	02197	BRG	AH	NBR
54,0	73,00	11,0	02207	BAGP	BI	ACM
54,0	76,00	8,0	01825	BRG	AH	NBR
54,0	76,20	12,7	01864	BAG	LI	NBR
54,0	77,70	11,0	02497	BRGF	AH	FPM
54,0	77,70	11,0	02660	BRGF	H	FPM
54,0	77,75	19,0	01012	BGO	LI	NBR
54,0	79,35	9,5	02287	BGP	BI	ACM
54,0	79,35	12,7	00436	B	LI	NBR
54,0	79,35	12,7	00436	BAG	H	NBR
54,0	79,40	12,7	01838	BAG	AH	NBR
54,0	90,00	12,5	02205	BAGP	BI	ACM
54,1	73,00	8,5	01930	BAG	LI	NBR
55,0	62,90	5,0	02847	GA	LI	NBR
55,0	65,00	5,0	02635	GR	LI	NBR
55,0	68,00	4,0	01035	GR	LI	NBR
55,0	70,00	8,0	01181	BR	LI	NBR
55,0	70,10	11,5	01557	BR	LI	NBR
55,0	72,00	9,0	02111	BRG	LI	NBR
55,0	72,00	10,0	01550	BR	LI	NBR
55,0	72,00	10,0	01550	BRP	LI	ACM
55,0	72,00	10,0	01969	BRGS	H	MVQ
55,0	72,00	10,0	07065	BR	LI	NBR
55,0	75,00	10,0	00804	BR	LI	NBR
55,0	75,00	12,0	00620	B	LI	NBR
55,0	76,00	12,0	01247	BA	LI	NBR
55,0	80,00	8,0	02529	BRG	H	NBR
55,0	80,00	10,0	00459	BR	LI	NBR
55,0	80,00	13,0	00498	BR	LI	NBR
55,0	85,00	13,0	01180	BR	LI	NBR
55,0	90,00	10,0	00793	BA	LI	NBR
55,0	90,00	12,5	00964	B	LI	NBR
55,0	100,00	12,7	01669	BR	LI	NBR
55,0	101,60	10,0	00776	BA	LI	NBR
55,1	82,00	10,0	01637	GA	LI	NBR
55,4	76,15	12,7	02415	BAG	LI	NBR
55,5	80,90	15,5	02181	BAG	H	NBR
56,0	85,00	13,0	00919	BR	LI	NBR
57,0	69,80	6,4	00456	BA	LI	NBR
57,0	71,00	9,0	05352	BRGF	H	FPM
57,0	85,00	12,0	02236	BAP	BI	ACM
57,1	76,05	12,7	07181	BR	AH	NBR

Diâmetro do Eixo	Diâmetro do Alojamento	Altura do Retentor	Número Sabó	Tipo	Orientação	Material do Lábio
57,1	76,10	11,0	02067	BAG	BI	NBR
57,1	76,20	12,7	02193	BRG	LI	NBR
57,1	80,00	13,0	00735	B	LI	NBR
57,2	73,00	8,0	02066	BAG	BI	NBR
57,2	76,00	9,5	01872	GA	LI	NBR
57,2	76,10	12,7	00013	B	LI	NBR
57,2	77,75	10,0	02667	BRGP	BI	ACM
57,2	79,30	12,7	00146	B	LI	NBR
57,2	80,00	12,7	00109	B	LI	NBR
57,2	82,45	9,5	02381	BA	BI	NBR
57,2	82,50	9,5	02103	BAG	AH	NBR
57,2	82,50	12,0	07262	BAGGP	AH	ACM
57,2	82,50	12,0	07267	BAGP	AH	ACM
57,2	82,50	12,7	00321	BA	LI	NBR
57,2	82,55	6,5	02316	GA	LI	NBR
57,2	85,00	12,7	00273	B	LI	NBR
57,2	92,00	18,0	00014	BGO	LI	NBR
57,3	76,20	9,5	01862	BAG	LI	NBR
57,3	76,20	12,7	00013	BRG	H	NBR
57,3	84,00	8,0	00188	BA	LI	NBR
58,0	74,00	10,0	05305	BRGF	AH	FPM
58,0	75,00	9,0	02112	BRG	LI	NBR
58,0	75,00	9,0	02426	BRG	AH	NBR
58,0	75,00	12,0	02100	BAG	AH	NBR
58,0	80,00	12,0	02326	BRGP	H	ACM
58,0	85,00	13,0	01798	BAG	LI	NBR
58,7	79,35	9,6	01995	BR	H	NBR
58,7	84,05	9,5	00010	GA	LI	NBR
58,7	85,00	8,0	00070	BA	LI	NBR
59,5	85,60	12,0	00547	B	LI	NBR
60,0	72,00	6,0	02636	GR	LI	NBR
60,0	73,00	10,5	07484	BRAGF	BI	FPM
60,0	75,05	8,0	00501	BR	LI	NBR
60,0	76,20	11,1	05126	BRG	AH	FPM
60,0	78,05	8,8	00305	BAG	LI	NBR
60,0	80,00	10,0	00223	BR	AH	NBR
60,0	80,00	10,0	02955	BRF	AH	FPM
60,0	80,00	12,0	01392	BAG	LI	NBR
60,0	80,00	13,0	00818	BR	LI	NBR
60,0	82,00	12,0	00977	BR	LI	NBR
60,0	82,00	12,0	01841	BRG	AH	NBR
60,0	82,00	12,0	01842	BRG	H	NBR
60,0	85,10	12,7	01194	BR	LI	NBR
60,0	90,00	8,0	02685	BR	LI	NBR
60,0	90,00	10,0	00517	BR	LI	NBR
60,2	85,75	9,5	01755	BA	BI	NBR
60,3	79,35	9,5	02077	BAG	H	NBR
60,3	79,40	12,0	02206	BAGP	BI	ACM
60,3	82,50	11,0	02116	BAP	H	ACM
60,3	85,00	12,0	00371	B	LI	NBR
60,3	85,05	6,4	01345	BA	LI	NBR
60,3	88,40	11,0	00021	B	LI	NBR
60,3	90,00	12,5	02204	BAGP	LI	ACM

Diâmetro do Eixo	Diâmetro do Alojamento	Altura do Retentor	Número Sabó	Tipo	Orientação	Material do Lábio
60,3	92,00	12,0	00334	BAG	H	NBR
60,4	79,35	9,3	01050	BR	LI	NBR
60,4	79,35	9,3	01050	BRGS	H	MVQ
60,4	79,40	9,3	02578	BRGF	H	FPM
61,9	79,95	10,0	01828	B	LI	NBR
62,0	85,00	10,0	00460	BR	LI	NBR
62,0	85,00	11,9	00805	BGO	LI	NBR
62,0	85,00	13,0	00044	BR	LI	NBR
62,0	92,00	9,5	00065	GA	LI	NBR
62,0	100,05	17,0	01425	BA	LI	NBR
63,0	81,00	10,0	01408	BA	LI	NBR
63,5	76,10	9,5	00907	BR	LI	NBR
63,5	76,20	6,4	01870	GA	LI	NBR
63,5	82,50	12,7	01790	B	LI	NBR
63,5	82,55	12,7	02478	BAGF	AH	FPM
63,5	82,55	12,7	02504	BAGP	AH	ACM
63,5	85,55	12,7	01541	BAG	LI	NBR
63,5	88,90	11,0	02498	BRGF	H	FPM
63,5	88,90	12,7	00120	BAG	LI	NBR
63,5	88,90	12,7	01863	BA	LI	NBR
63,5	88,90	17,8	00652	BG	LI	NBR
63,5	89,90	12,0	00378	B	LI	NBR
63,5	110,00	13,0	01462	B	LI	NBR
63,6	88,90	13,5	02256	BAG	BI	NBR
63,9	73,00	3,2	02255	GA	LI	NBR
64,0	80,00	8,0	02004	BAGP	AH	ACM
64,0	80,00	8,0	05062	BRAG	AH	FPM
64,0	80,00	9,0	05055	BRAGF	H	FPM
64,0	90,00	10,0	02399	BRGS	H	MVQ
65,0	80,00	8,0	01160	BR	LI	NBR
65,0	85,00	10,0	02530	BRG	LI	NBR
65,0	85,10	10,0	00926	BR	LI	NBR
65,0	88,30	12,7	01454	BGO	LI	NBR
65,0	88,45	12,7	00903	BA	LI	NBR
65,0	90,00	10,0	00051	BRP	LI	ACM
65,0	90,00	13,0	00164	BAG	LI	NBR
65,0	90,00	13,0	00164	BR	LI	NBR
65,0	90,00	15,0	01810	BAGS	H	MVQ
65,0	90,00	15,0	01810	BRAGS	H	MVQ
65,0	92,00	17,8	01489	BGO	LI	NBR
65,0	100,00	13,0	02113	BR	AH	NBR
65,8	88,40	12,7	00058	B	LI	NBR
66,7	85,60	12,0	02272	BGP	BI	ACM
66,7	88,35	12,7	00651	B	LI	NBR
66,7	88,90	12,7	00369	BR	LI	NBR
66,7	92,00	11,0	02271	BGP	BI	ACM
66,7	92,00	12,0	00030	B	LI	NBR
66,7	95,25	12,7	00379	BR	LI	NBR
66,7	112,65	11,0	00434	B	LI	NBR
68,0	85,00	10,0	02556	BAF	H	FPM
68,0	85,00	10,0	02557	BRG	LI	NBR
68,0	85,00	10,0	07603	BRAF	H	FPM
68,0	90,00	10,0	00228	BAG	LI	NBR

Diâmetro do Eixo	Diâmetro do Alojamento	Altura do Retentor	Número Sabó	Tipo	Orientação	Material do Lábio
68,0	90,00	10,0	02292	BAF	AH	FPM
68,0	90,00	10,0	02445	BR	LI	NBR
68,0	90,00	13,0	00500	BAG	H	NBR
68,0	90,00	13,0	00500	BAGF	H	FPM
68,0	90,00	13,0	00500	BAGP	H	ACM
68,0	90,00	13,0	01762	BAGF	AH	FPM
69,8	90,00	8,0	02422	BRP	BI	ACM
69,8	90,00	10,0	02423	BAG	LI	NBR
69,8	92,00	11,0	02499	BRGF	AH	FPM
69,8	92,00	14,2	00891	BRG	LI	NBR
69,8	95,20	12,7	00376	B	LI	NBR
69,8	95,25	16,0	01865	BGO	LI	NBR
69,8	98,45	11,8	01880	BAG	H	NBR
69,9	88,90	12,7	02085	BA	AH	NBR
69,9	92,25	12,7	02560	BGF	AH	FPM
69,9	98,45	12,7	00081	B	LI	NBR
70,0	85,00	7,0	02637	GR	LI	NBR
70,0	85,00	8,0	00906	BR	LI	NBR
70,0	85,00	8,0	02269	BAGP	AH	ACM
70,0	85,00	8,0	02297	BAGF	AH	FPM
70,0	85,00	8,0	02398	BAGS	AH	MVQ
70,0	85,00	8,0	02677	BRG	LI	NBR
70,0	90,00	10,0	01135	BR	AH	NBR
70,0	90,00	10,0	01135	BRGS	AH	MVQ
70,0	90,00	10,0	01135	BRP	AH	ACM
70,0	90,00	10,0	02192	BRGP	BI	ACM
70,0	90,00	13,0	00490	BR	LI	NBR
70,0	90,00	15,0	02061	BRGF	H	FPM
70,0	90,50	10,0	01927	BRP	AH	ACM
70,0	95,00	13,0	01879	BRG	AH	NBR
70,0	100,00	10,0	00866	BR	LI	NBR
70,0	100,00	12,0	00423	BR	LI	NBR
72,2	100,00	12,7	00087	B	LI	NBR
72,5	92,20	9,0	02759	BAG	AH	NBR
73,0	95,20	12,7	00098	B	LI	NBR
73,0	101,60	12,7	00116	B	LI	NBR
74,0	90,00	10,0	01044	BAG	LI	NBR
74,0	90,00	10,0	05075	BRAGF	AH	FPM
74,0	114,00	11,0	00573	B	LI	NBR
74,6	101,60	17,4	00323	BGO	LI	NBR
74,9	100,00	13,0	01687	BA	H	NBR
75,0	90,00	10,0	02451	BRG	LI	NBR
75,0	90,00	12,0	00893	BA	LI	NBR
75,0	95,00	5,0	01673	BA	LI	NBR
75,0	95,00	10,0	02531	BR	BI	NBR
75,0	95,00	10,0	07290	BRAGF	BI	FPM
75,0	95,00	12,0	02191	BRF	AH	FPM
75,0	95,00	13,0	02753	BRG	LI	NBR
75,0	95,10	13,0	00046	BR	LI	NBR
75,0	100,00	10,0	00609	BR	LI	NBR
75,0	100,00	10,0	02671	BRGF	BI	FPM
75,0	100,00	12,0	00269	BR	LI	NBR
75,0	100,00	13,0	02226	BG	BI	NBR

Diâmetro do Eixo	Diâmetro do Alojamento	Altura do Retentor	Número Sabó	Tipo	Orientação	Material do Lábio
75,0	100,00	17,0	02199	BAGF	H	FPM
75,0	100,00	12,0/13,0	00269	BAGS	H	MVQ
75,0	105,00	13,0	01183	BR	LI	NBR
75,9	95,00	11,3	01856	BRGP	AH	ACM
76,0	89,70	5,5	02780	BRF	AH	FPM
76,2	95,25	9,7	01852	BRS	AH	MVQ
76,2	98,45	11,9	01857	B	LI	NBR
76,2	101,65	11,0	02127	BGP	H	ACM
76,2	101,65	12,0	00357	B	LI	NBR
76,2	101,65	12,0	00357	BA	LI	NBR
78,0	100,00	13,0	01917	BRGS	H	MVQ
78,0	110,00	13,0	00819	BR	LI	NBR
79,0	95,30	11,0	05166	BRGS	AH	MVQ
79,0	111,55	10,7	01301	BA	LI	NBR
79,4	104,65	12,7	00221	B	LI	NBR
79,4	109,90	13,0	00466	B	LI	NBR
79,4	114,30	12,7	01148	BR	LI	NBR
79,4	117,40	14,3	00008	B	LI	NBR
80,0	98,00	10,0	02524	BRAGF	AH	FPM
80,0	98,00	10,0	05521	BRAGF	AH	FPM
80,0	100,00	10,0	00610	BR	LI	NBR
80,0	100,00	10,0	02664	BAGP	BI	ACM
80,0	100,00	10,0	03017	BAGF	BI	FPM
80,0	100,00	12,0	02235	BAGS	H	MVQ
80,0	100,00	12,0	02291	BAF	H	FPM
80,0	100,00	12,0	02661	BRG	H	NBR
80,0	100,00	12,0	02662	BRG	AH	NBR
80,0	100,00	13,0	00504	BGO	LI	NBR
80,0	110,00	12,0	00900	BR	LI	NBR
81,0	114,20	12,0	00134	B	LI	NBR
81,0	117,50	14,3	00002	B	LI	NBR
82,0	104,70	14,3	00593	B	LI	NBR
82,0	105,00	12,0	01945	BRGS	AH	MVQ
82,0	105,00	13,0	00480	BA	LI	NBR
82,5	107,85	11,9	00644	B	LI	NBR
82,5	107,85	11,9	00644	BGO	LI	NBR
82,5	114,30	12,7	01923	BG	BI	NBR
82,5	120,00	15,0	02416	BAG	BI	NBR
82,6	107,90	14,3	01195	B	LI	NBR
84,0	110,05	16,0	00612	BR	LI	NBR
85,0	105,00	10,0	02606	BAF	H	FPM
85,0	105,00	10,0	02801	BAF	AH	FPM
85,0	105,00	11,0	02607	BRG	LI	NBR
85,0	105,00	12,0	01981	BRGS	AH	MVQ
85,0	105,00	12,0	02283	BRGF	AH	FPM
85,0	110,00	12,0	01767	BR	LI	NBR
85,0	110,00	14,0	00618	BAG	LI	NBR
85,7	107,85	12,7	02352	B	LI	NBR
85,7	114,20	11,2	01912	BRG	LI	NBR
85,7	114,33	13,0	05304	BRAGF	H	FPM
85,7	119,00	12,7	00025	B	LI	NBR
85,9	104,00	11,0	02264	BRGF	AH	FPM
87,3	120,80	14,3	00085	B	LI	NBR

Diâmetro do Eixo	Diâmetro do Alojamento	Altura do Retentor	Número Sabó	Tipo	Orientação	Material do Lábio
88,0	108,00	10,1	05254	BRGF	AH	FPM
88,0	110,00	13,0	00737	BA	LI	NBR
88,9	126,90	12,7	00642	B	LI	NBR
89,0	111,10	12,7	00577	BGOP	LI	ACM
89,0	114,00	13,0	07220	BRG		NBR
89,0	114,25	12,7	01253	B	LI	NBR
89,0	114,25	12,7	02424	BG	LI	NBR
89,0	114,30	11,5	00300	B	LI	NBR
90,0	104,00	11,0	05343	BRAGF	AH	FPM
90,0	110,00	9,0	05420	BRGF	AH	FPM
90,0	110,00	12,0	02574	BR	BI	NBR
90,0	110,05	13,0	01416	BAG	LI	NBR
90,0	112,70	13,0	01829	B	LI	NBR
90,0	115,00	13,0	02325	BRGP	AH	ACM
90,0	120,00	12,0	02208	BAGP	BI	ACM
90,0	120,00	12,0	02751	BRG	BI	NBR
90,0	120,00	13,0	00497	BRG	LI	NBR
90,1	110,00	13,0	02450	BRGP	H	ACM
92,0	126,85	12,7	00366	B	LI	NBR
92,1	107,70	10,0	02604	BRGF	AH	FPM
92,1	123,85	21,0	01251	BGO	LI	NBR
92,1	123,95	15,8	00442	BR	LI	NBR
94,9	129,95	13,0	01043	B	LI	NBR
95,0	115,00	13,0	02690	BRG	BI	NBR
95,0	115,00	13,0	02938	BRAG	BI	NBR
95,0	125,00	13,0	00045	B	LI	NBR
95,3	114,25	12,0	02125	BGP	AH	ACM
95,3	120,55	12,7	01257	B	LI	NBR
98,4	126,90	12,0	02213	B	LI	NBR
98,5	144,45	19,0	00007	B	LI	NBR
99,9	130,00	12,0	07121	BR	LI	NBR
100,0	119,95	13,0	02049	BG	BI	NBR
100,0	119,95	13,0	07369	BG	BI	NBR
100,0	120,00	11,0	01375	BR	LI	NBR
100,0	123,80	13,0	01801	B	LI	NBR
100,0	125,00	12,0	01549	BR	LI	NBR
100,0	125,00	12,0	01968	BRS	AH	MVQ
100,0	125,00	12,0	07322	BRA	LI	NBR
100,0	129,90	13,0	07323	BRG	LI	NBR
100,0	130,00	12,0	01721	BR	LI	NBR
100,0	130,00	12,0	01721	BRGP	LI	ACM
100,0	130,00	13,0	00043	BA	LI	NBR
100,0	130,00	13,0	01974	BRG	LI	NBR
100,0	162,10	15,0	00439	BR	LI	NBR
101,6	125,00	13,0	05421	BRGF	AH	FPM
101,6	126,90	11,2	02117	BAS	AH	MVQ
101,6	126,90	12,7	00123	B	LI	NBR
101,6	130,05	14,3	00631	B	LI	NBR
101,6	139,75	14,3	01252	BGO	LI	NBR
101,8	127,10	11,9	01901	BGO	LI	NBR
102,0	130,00	13,0	00616	BR	LI	NBR
105,0	130,00	12,0	02985	BRF	AH	FPM
105,0	130,00	13,0	00491	B	LI	NBR

Diâmetro do Eixo	Diâmetro do Alojamento	Altura do Retentor	Número Sabó	Tipo	Orientação	Material do Lábio
105,0	135,00	15,0	01774	BRG	LI	NBR
105,0	140,00	12,0	02195	BR	BI	NBR
105,0	142,90	12,7	01268	BA	LI	NBR
106,4	126,90	12,0	00650	B	LI	NBR
108,0	133,25	9,5	01103	B	LI	NBR
108,0	133,25	12,0	00536	B	LI	NBR
108,0	133,35	12,0	02386	BG	BI	NBR
108,0	136,50	12,7	01468	B	LI	NBR
108,2	144,45	19,0	02021	B	BI	NBR
110,0	130,00	13,0	00803	BAG	LI	NBR
110,0	130,00	13,0	00803	BAS	LI	MVQ
110,0	130,00	13,0	00803	BRGS	AH	MVQ
110,0	139,95	13,0	00516	B	LI	NBR
110,0	139,95	13,0	00516	BG	BI	NBR
110,0	180,00	15,0	01427	BR	LI	NBR
110,3	133,30	12,0	01739	B	LI	NBR
112,5	130,00	11,0	05150	BRAGF	AH	FPM
114,3	139,65	12,7	02214	B	LI	NBR
114,3	139,65	14,3	00125	B	LI	NBR
114,3	152,40	12,7	01412	B	LI	NBR
114,3	155,55	14,0	02180	BG	BI	NBR
115,0	140,00	13,0	00514	BR	LI	NBR
117,4	142,87	12,5	07461	BRF	LI	FPM
117,5	146,00	14,3	02092	BGO	BI	NBR
118,0	140,00	13,0	01770	B	LI	NBR
119,0	146,00	14,3	00099	B	LI	NBR
119,0	162,10	15,0	00546	BR	LI	NBR
119,5	144,95	15,0	07372	BRAG	BI	NBR
120,0	140,00	13,0	00688	BAP	AH	ACM
120,0	140,00	13,0	02697	BRAG	AH	FPM
120,0	140,15	13,0	01885	BAGP	H	ACM
120,0	144,95	15,0	01884	BG	BI	NBR
120,7	146,05	12,5	00250	BR	LI	NBR
120,7	146,05	12,5	00250	BRP	LI	ACM
122,2	140,80	11,8	02115	BRGS	AH	MVQ
122,2	140,80	11,8	02612	BRGF	AH	FPM
122,2	140,80	12,0	02449	BRGF	AH	FPM
125,0	150,00	13,0	02868	BRG	BI	NBR
125,0	150,00	15,0	01735	BG	BI	NBR
125,0	150,00	15,0	02156	BAGF	AH	FPM
125,0	150,00	15,0	02941	BRAG	BI	NBR
125,0	150,10	13,0	00420	BR	LI	NBR
125,0	160,00	12,0	00780	BR	LI	NBR
127,0	158,70	12,7	00309	B	LI	NBR
127,0	165,10	16,0	00310	B	LI	NBR
130,0	160,00	12,0	01193	BR	LI	NBR
130,0	160,00	13,0	01822	BAP	LI	ACM
130,0	160,00	15,0	02069	BRGS	AH	MVQ
133,0	160,00	15,0	01953	BRG	AH	NBR
133,0	160,00	15,0	01953	BRGP	AH	ACM
133,3	158,75	13,0	01972	BRGS	AH	MVQ
133,3	158,75	13,0	02583	BRGF	AH	FPM
133,4	155,55	14,0	02245	BAG	BI	NBR

Diâmetro do Eixo	Diâmetro do Alojamento	Altura do Retentor	Número Sabó	Tipo	Orientação	Material do Lábio
133,4	165,10	15,9	01362	B	H	NBR
135,0	189,95	15,0	00042	BR	LI	NBR
136,5	168,25	15,9	00649	B	LI	NBR
136,5	168,25	15,9	00649	BGO	LI	NBR
140,0	165,00	15,0	02185	BAGF	AH	FPM
140,0	170,00	13,0	00502	BR	LI	NBR
140,0	180,00	15,0	02223	B	LI	NBR
142,9	171,05	14,3	00248	BR	LI	NBR
145,0	175,00	13,0	02293	BF	BI	FPM
145,0	175,00	13,0	02778	B	BI	NBR
145,0	175,00	14,0	02679	BRG	LI	NBR
146,0	168,25	16,0	01928	B	H	NBR
149,2	181,00	12,7	00211	BGO	LI	NBR
150,0	180,00	13,0	01910	BRP	H	ACM
150,0	180,00	13,0	01910	BRS	H	MVQ
150,0	180,00	15,0	01424	BR	LI	NBR
150,0	180,00	15,0	02932	BAGF	BI	FPM
150,0	180,00	15,0	02933	BRG	LI	NBR
150,8	177,80	12,5	02093	BRG	LI	NBR
155,0	180,00	15,0	05414	BRAGF	AH	FPM
160,0	200,00	12,0	01951	BR	LI	NBR
161,9	187,30	9,5	02054	BR	LI	NBR
165,0	190,00	12,9	00160	BR	LI	NBR
165,0	190,50	12,7	02056	BR	LI	NBR
165,1	193,65	15,7	01976	B	LI	NBR
168,0	188,00	31,5	02246	BAG	BI	NBR
174,6	200,00	16,0	02138	B	LI	NBR
185,0	210,00	13,0	01676	BR	LI	NBR
190,0	220,00	14,8	00268	BR	LI	NBR
190,0	220,00	14,8	00268	BRP	LI	ACM

Grupo
A

Tipos Alternativos

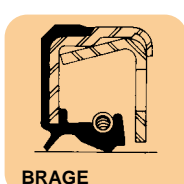
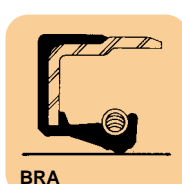
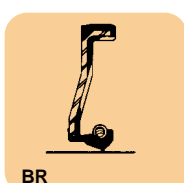
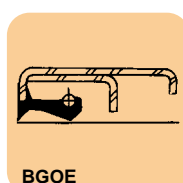
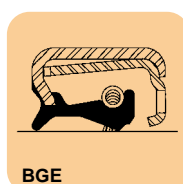
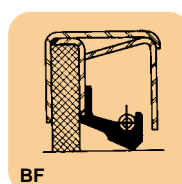
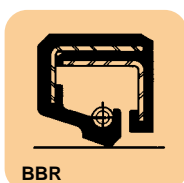
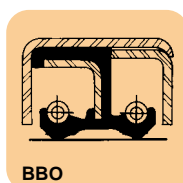
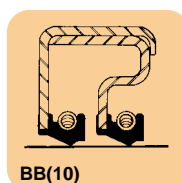
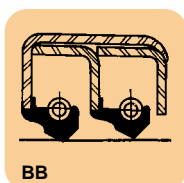
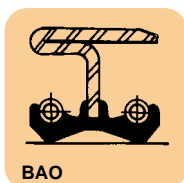

Diâmetro do Eixo	Diâmetro do Alojamento	Altura do Retentor	Número Sabó	Tipo	Orientação	Material do Lábio
9,0	16,00	9,0/15,0	01662	GAE	LI	NBR
10,0	19,35	2,3/7,5	01741	GE	LI	NBR
11,0	16,60	6,0/8,5	02239	GAE	LI	NBR
14,0	20,00	2,5	02534	GAG	LI	NBR
14,0	26,85	10,1	03113	BRGH	LI	HNBR
14,2	28,55	13,5	02576	GAG	LI	NBR
15,0	21,00	5,0/6,5	07063	BRAG	LI	NBR
15,0	22,00	4,0	02441	GRG	LI	NBR
15,0	24,00	6,0	07002	GRG	LI	HNBR
15,0	34,95	10,0/12,7	01889	GAO	LI	NBR
15,0	35,00	8,0	02683	GAG	LI	NBR
15,9	28,55	9,5	00156	BRO	LI	NBR
15,9	30,00	2,0/8,0	05049	BRGGF	H	FPM
16,0	23,00	3,3	02875	GRG	LI	NBR
16,5	25,00	5,0	02876	GRG	LI	NBR
17,0	28,00	8,0	01784	BRO	LI	NBR
17,0	28,55	6,4	00342	GAG	LI	NBR
17,0	30,00	7,0	02963	BROF	LI	FPM
17,8	32,15	5,5	02216	GAG	LI	NBR
19,0	35,00	2,2	03010	GR	LI	NBR
20,0	26,00	4,0	02592	GAG	LI	NBR
20,0	27,00	5,0	02700	GRG	LI	NBR
20,0	28,00	4,0	02526	GAG	LI	NBR
20,0	30,00	4,0	03003	GRE	LI	NBR
20,0	30,00	4,0/7,0	01566	BAO	LI	NBR
20,0	35,00	7,0/10,6	02075	BREP	H	ACM
20,0	38,05	18,3	02070	BBO	LI	NBR
20,0	47,00	10,0/12,7	01129	GAE	LI	NBR
20,0	47,00	10,0/12,7	01129	GRO	LI	NBR
20,0	52,00	10,0/13,0	02232	GAO	LI	NBR
21,0	32,00	7,0	07134	BGE	H	NBR
21,0	32,00	9,0	07496	BGE	H	NBR
21,0	37,00	7,0/10,0	02143	BRGGG	LI	NBR
22,0	31,75	6,0	02763	BAE ⁽⁰⁷⁾	LI	NBR
22,0	40,00	8,0	03019	BRAGEP	H	ACM
22,1	40,00	12,0/17,0	00224	BRGE ⁽⁰²⁾	H	ACM
22,2	27,95	8,0	02814	GRG ⁽⁰⁹⁾	LI	NBR
22,8	40,00	6,5/8,0	07137	BGEP	H	ACM
23,0	37,00	13,5	02467	BAGAP	BI	ACM
23,0	37,00	7,0/11,0	02967	BRGE	LI	NBR
24,6	46,40	14,7	01401	BB	LI	NBR
25,0	35,00	5,0/7,0	02261	GAE	LI	NBR
25,0	47,00	8,0	02241	GRG	LI	NBR
25,0	52,00	10,0/12,7	01890	GAO	LI	NBR
25,0	62,00	10,0/13,0	02231	GAO	LI	NBR
25,4	38,10	6,3/8,8	01356	BAG	LI	NBR
25,4	44,50	14,3	00327	BF	LI	NBR/FE
25,6	42,00	7,0/10,3	01765	BRE	BI	NBR
26,0	34,00	5,0	02259	GAG	LI	NBR
26,0	42,00	8,0	02657	BRAGS	H	MVQ
28,0	39,95	8,0	02157	BRO	LI	NBR
28,0	52,00	6,0/9,0	02728	BRGE ⁽⁰⁴⁾	AH	NBR
29,9	42,00	7,0	02681	BRAGF	H	FPM

Grupo
A

Tipos Alternativos

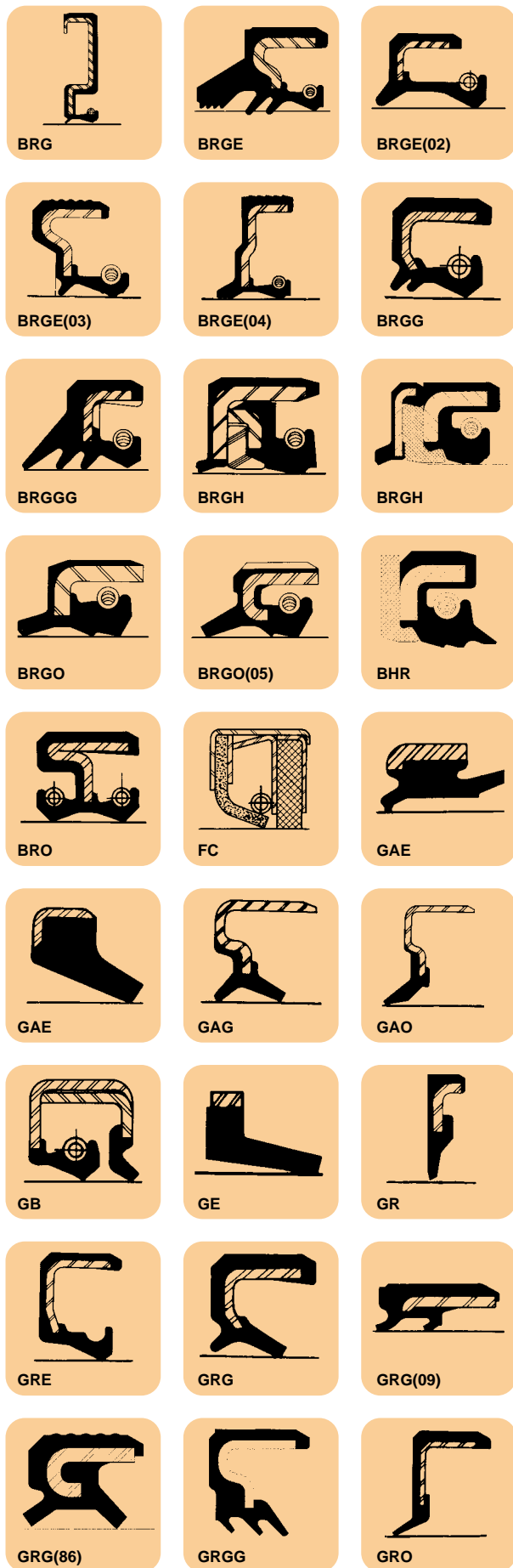

Diâmetro do Eixo	Diâmetro do Alojamento	Altura do Retentor	Número Sabó	Tipo	Orientação	Material do Lábio
30,0	47,00	8,0	02966	BRGG	LI	NBR
30,0	50,00	7,0	02817	BRAGF	H	FPM
30,0	52,00	7,0	02936	BRAGP	H	ACM
30,0	72,00	6,5	02672	BRG	BI	NBR
31,0	43,00	10,3	03249	BRO	LI	NBR
31,0	50,00	8,0	02317	BRAGF	H	FPM
31,0	62,10	4,0/5,5	02595	BRF	LI	FPM
31,8	44,73	6,4	03245	BRH	LI	NBR
34,0	55,00	11,0/15,0	02152	BAGGG	LI	NBR
34,5	46,50	6,5	02482	GRG	LI	NBR
35,0	48,00	7,0	02178	BRAGS	H	MVQ
35,0	48,00	11,0	03248	BRO	LI	NBR
35,0	48,50	5,0/7,0	02903	GRO	LI	NBR
35,0	65,00	8,0	02481	BRAGF	BI	FPM
38,0	50,00	8,0	02794	BRAGF	H	FPM
38,0	50,00	10,0/16,0	00954	BAE	LI	NBR
38,1	50,35	10,9	01803	BAG	LI	NBR
38,1	57,10	11,0	00254	BAO	LI	NBR
38,1	63,45	19,0	01033	BB	LI	NBR
39,4	60,30	12,7	01997	BRO	LI	NBR
39,4	80,20	6,4/11,8	01660	BAGE ⁽⁰⁶⁾	H	NBR
40,0	50,00	5,0	02469	GRG	LI	NBR
40,0	52,00	7,0	01988	BAGE	LI	NBR
40,0	55,00	8,0	02911	BRAGP	AH	ACM
40,0	55,00	8,8	02859	BRGH	LI	NBR/ FPM/ NY
40,0	56,00	7,0	02893	BRAGP	H	ACM
40,0	56,00	7,0	02844	BRAGF	H	FPM
40,0	60,00	10,0/11,5	02741	BRGGP	BI	ACM
40,0	62,00	12,0	01684	BRGGG	LI	NBR
40,0	66,00	7,0	07387	GAE	LI	NBR
40,1	52,00	7,9	01988	BAGE	LI	NBR
41,0	73,00	13,0	02737	GB	LI	NBR
42,0	55,00	10,0	02682	BRAGF	AH	FPM
42,0	72,00	10,0	02494	BRAGF	H	FPM
42,9	73,00	15,9	01996	BRO	LI	NBR
44,4	53,95	8,6	01858	BAGE	LI	NBR
44,5	57,07	10,9	01575	GGO	LI	NBR
44,5	59,25	6,0	01756	GAG	LI	NBR
44,5	85,60	16,0	00695	GB	LI	NBR
44,7	61,20	8,8	02862	BRAGF	H	FPM
45,0	56,00	6,0/7,0	02905	BRGG	LI	NBR
45,0	73,12	13,0	02395	BAGG	BI	NBR
47,0	58,00	7,0	02024	BRGG	LI	NBR
47,0	60,00	7,0	02965	BRGG	LI	NBR
47,7	73,10	9,5/17,5	07395	BRAGGG	BI	NBR
49,0	76,00	17,4	01199	GB	LI	NBR
50,0	65,00	9,0	02818	BRAGF	H	FPM
50,0	80,00	12,0	02547	BRO	LI	NBR
51,0	65,00	7,0	02777	BRAS	H	MVQ
52,4	76,00	7,9	00974	GAO	LI	NBR
55,0	70,10	8,0	02656	BRAF	AH	FPM
57,5	74,00	8,5	05413	GRGG	LI	NBR

Grupo
A

Tipos Alternativos

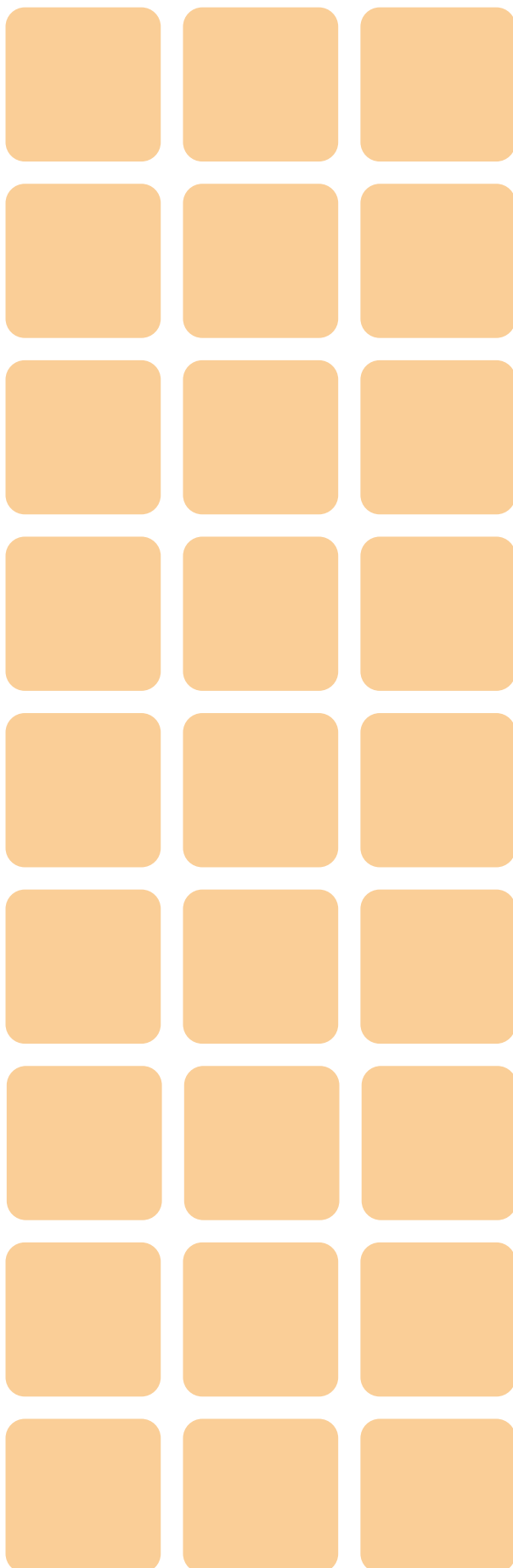

Diâmetro do Eixo	Diâmetro do Alojamento	Altura do Retentor	Número Sabo	Tipo	Orientação	Material do Lábio
59,9	85,50	17,5	00556	GB	LI	NBR
60,3	82,50	11,0	02448	BRAGF	H	FPM
60,3	85,75	23,8	02267	BBO	LI	NBR
63,0	110,00	13,0	02735	GB	LI	NBR
63,5	89,90	22,2	01125	BBO	LI	NBR
65,0	85,00	10,0/13,0	02688	BAGGF	BI	FPM
66,7	88,80	11,0/12,5	02511	BRAGF	H	FPM
66,7	101,60	17,4	01689	GB	LI	NBR
70,0	85,00	8,0	02845	BRAGF	AH	FPM
70,0	85,00	8,0	02946	BRAGP	AH	ACM
70,0	86,00	10,0	02546	BRO	BI	NBR
70,0	90,00	12,7	02961	BAGGP	AH	ACM
70,0	90,00	14,0	02695	BRGGG	LI	NBR
73,0	101,60	11,5	00421	BAGG	BI	NBR
73,0	101,60	18,3	02036	GB	LI	NBR
73,0	101,65	17,4	01091	GB	LI	NBR
73,5	95,00	18,0	02017	GB	LI	NBR
76,2	101,60	19,0	00377	BB	LI	NBR
77,0	100,10	11,5	02345	BRAGF	AH	FPM
78,0	100,05	12,0	02871	BRAGF	H	FPM
79,0	110,00	17,4	02035	GB	LI	NBR
80,0	98,00	10,0	02702	BRAGF	AH	FPM
81,0	100,10	11,5	02898	BRAGF	AH	FPM
82,5	114,30	12,7	01923	BGG	BI	NBR
82,6	107,85	16,0	01571	BBR	LI	NBR
85,0	105,00	12,0	02925	BRAGF	AH	FPM
87,3	114,30	22,2	01791	BF	LI	NBR/FE
90,0	104,00	11,0	02600	BRAGF	AH	FPM
90,0	104,00	11,0	02900	BRAGF	AH	FPM
91,0	111,00	10,0	02629	BRAGF	AH	FPM
92,2	123,85	19,0	02037	GB	LI	NBR
94,7	120,00	12,0	02464	BRO	LI	NBR
97,8	116,00	16,0	02060	GB	LI	NBR
101,6	127,00	16,0	02194	GB	LI	NBR
104,8	139,60	14,3	00744	BBO	LI	NBR
105,0	130,00	12,0	02696	BRAGF	H	FPM
105,0	135,00	12,0	02347	GRE	LI	NBR
108,0	133,30	9,5	01103	GB	LI	NBR
110,0	130,00	13,0	02973	BRAGF	AH	FPM
112,5	130,00	11,0	02619	BRAGF	AH	FPM
125,0	150,00	12,0	02770	BB ⁽¹⁰⁾	LI	NBR
125,0	150,00	15,0	01735	BE	LI	NBR
125,0	150,00	15,0	01735	BG	LI	NBR
125,0	150,00	31,7	02545	BROF	BI	FPM
130,0	160,00	12,0	02872	BRAGF	AH	FPM
139,7	160,25	31,7	02089	BGOE	LI	NBR
150,0	180,00	15,0	02771	BB	LI	NBR

Tipos Alternativos

Grupo B

Retentores com 2 alturas

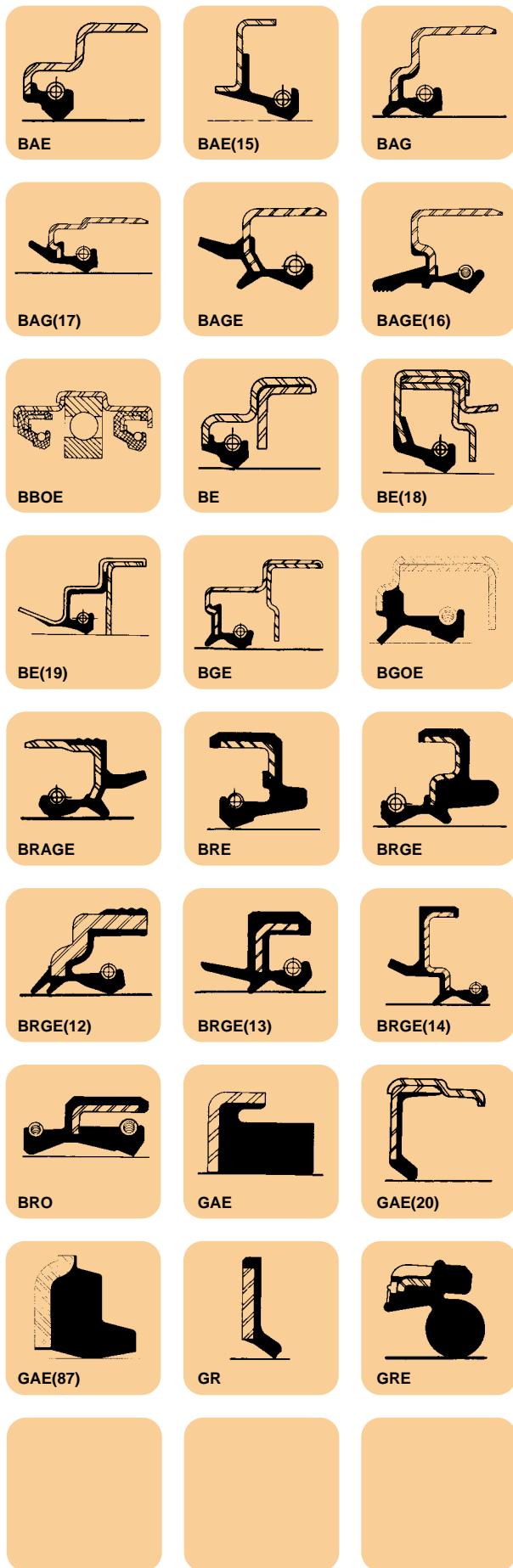

Diâmetro do Eixo	Diâmetro do Alojamento	Altura do Retentor	Número Sabó	Tipo	Orientação	Material do Lábio
11,8	28,00	5,0/7,5	03202	GAEP	LI	ACM
16,7	35,00	6,5/8,3	02618	GRG	LI	CR
19,9	44,40	1,6/7,9	01723	BAE	LI	NBR
23,3	29,70	1,8/4,3	03009	BREF	LI	FPM
24,6	44,50	1,5/7,9	01722	BAE	LI	NBR
25,0	35,00	3,8/7,5	02434	BRE	LI	NBR
27,0	42,70	1,2/7,9	01724	BAE	LI	NBR
29,8	50,00	10,0/13,5	07139	BAGEP	H	ACM
29,8	50,00	10,0/13,5	07539	BRAGEP	H	ACM
29,8	52,00	10,0/13,5	07138	BAGEP	AH	ACM
29,8	52,00	10,0/13,5	07538	BRAGEP	AH	ACM
33,0	50,00	10,0/15,0	01834	BAGE	AH	NBR
35,0	54,00	10,0/15,0	02370	BRAGE	BI	NBR
35,0	54,90	8,9/14,7	07398	BAGEF	BI	FPM
38,1	60,30	12,7/17,7	00049	BAGE	AH	NBR
38,1	60,30	12,7/17,7	07126	BAGE	AH	NBR
38,1	60,30	12,7/15,9	07199	BAGEP	H	ACM
39,4	69,85	6,4/16,2	01897	BRGEP	H	ACM
39,4	80,10	6,4/16,2	02155	BRGE	AH	NBR
39,4	80,25	6,4/16,2	01898	BRGEP	H	ACM
39,7	80,20	6,4/15,0	00029	BAE ⁽¹⁵⁾	LI	NBR
42,0	72,00	10,0/16,0	07500	BRAGEF	H	FPM
42,9	65,00	9,5/15,0	01899	BRGE	BI	NBR
43,7	71,90	9,0/21,6	00022	BAE	LI	NBR
43,7	72,10	9,0/21,6	00023	BAE	LI	NBR
44,2	71,40	10,0/16,5	02910	BAGE	H	NBR
46,0	65,50	9,0/13,2	01111	BRGE	LI	NBR
46,0	76,20	9,5/12,7	01049	BRE	LI	NBR
47,6	70,65	14,4/16,7	00092	BGOE	LI	NBR
47,6	80,00	13,0/26,0	02209	BAGE	BI	NBR
47,6	80,25	6,5/16,5	02201	BRGEP ⁽¹⁴⁾	H	ACM
47,8	60,90	6,4	00220	BAE	LI	NBR
49,2	80,10	8,1/22,2	00078	BAE	LI	NBR
50,0	65,00	9,7/14,0	02442	BAGE	BI	NBR
50,0	81,00	18,0/53,0	01077	BBOE	LI	NBR
54,0	79,35	12,7/19,0	00436	BAGE	H	NBR
54,0	79,35	12,7/19,0	02393	BAGE	AH	NBR
54,0	80,00	11,1/16,6	02693	BRGE ⁽¹²⁾	BI	NBR
55,0	70,00	6,0/10,3	02392	BRGE ⁽¹³⁾	BI	NBR
57,2	82,50	9,5/11,5	02103	BAGE ⁽¹⁶⁾	AH	NBR
58,0	80,00	4,5/10,5	02996	BRGEP	H	ACM
59,0	79,70	9,7/11,8	01932	GRE	LI	NBR
60,2	84,05	8,0/12,7	00474	GAE ⁽²⁰⁾	LI	NBR
60,3	91,40	6,4/15,3	00168	BAE	LI	NBR
60,3	92,00	12,0/18,0	00334	BAGE	H	NBR
60,3	92,00	12,0/18,5	02417	BAGE	AH	NBR
63,5	83,80	9,0/11,5	02211	BAG	BI	NBR
69,8	98,45	11,8/17,7	01880	BAGE	H	NBR
69,8	98,45	11,8/17,8	02366	BAGE	AH	NBR
73,0	104,70	9,6/20,6	00181	BE	LI	NBR
79,4	115,85	10,1/30,5	00003	BE ⁽¹⁸⁾	LI	NBR
80,0	112,00	12,0/18,0	02351	BAGE	H	NBR
81,0	117,50	14,5/19,0	00001	BE ⁽¹⁹⁾	LI	NBR

Tipos Especiais



Retentores com 2 alturas

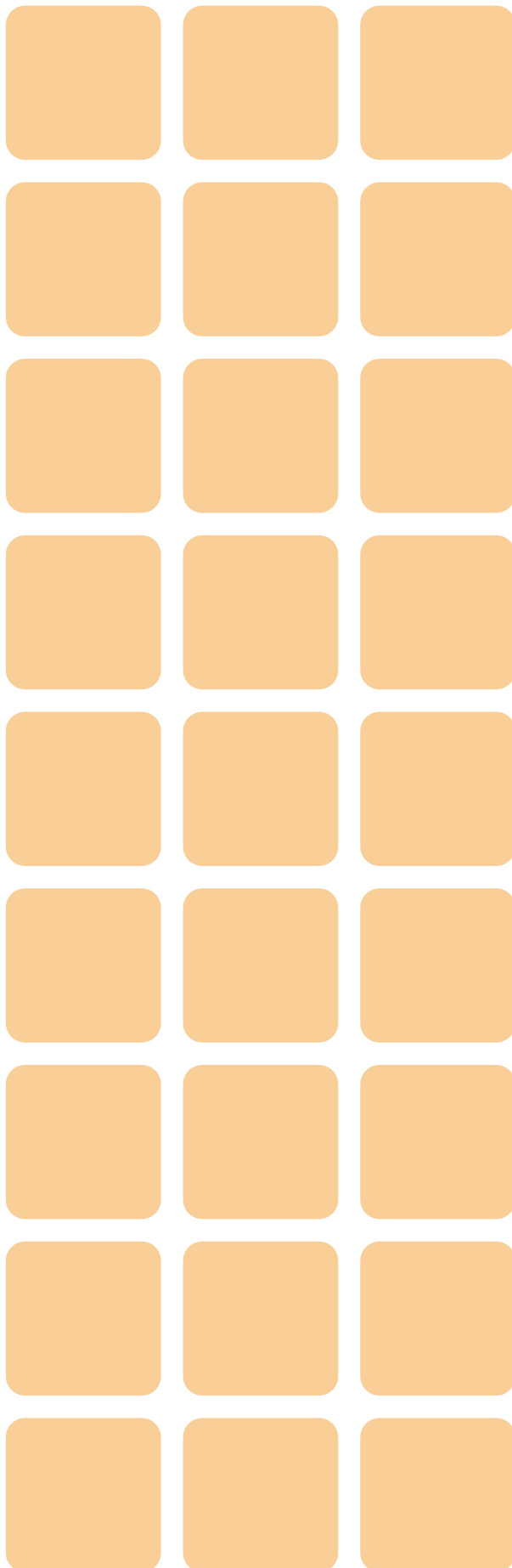

Diâmetro do Eixo	Diâmetro do Alojamento	Altura do Retentor	Número Sabó	Tipo	Orientação	Material do Lábio
85,7	107,95	7,9/14,6	01900	GAE	LI	NBR
88,9	115,40	16,2/19,2	02483	BGE	BI	NBR
88,9	115,40	16,2/19,2	07414	BGE	BI	NBR
88,9	122,95	18,7/21,7	02484	BGE	BI	NBR
88,9	122,95	18,7/21,7	07415	BGE	BI	NBR
90,0	115,00	4,1/13,0	02997	BRGEP	AH	ACM
92,0	123,75	15,0/19,0	00018	BE	LI	NBR
100,0	128,00	15,0/25,0	01805	BE	LI	NBR
117,4	157,10	13,5/26,5	02134	BGE	BI	NBR
144,6	170,00	15,0/20,6	07281	BAE	LI	NBR
155,0	180,00	16,0/29,0	02219	BAGF ⁽¹⁷⁾	BI	FPM

Grupo **D**

Retentores para Movimento Axial

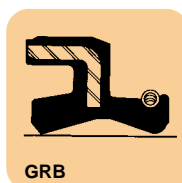
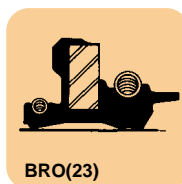
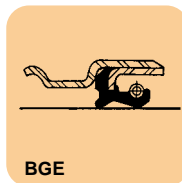
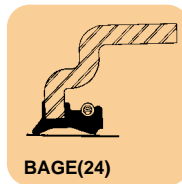

Diâmetro do Eixo	Diâmetro do Alojamento	Altura do Retentor	Número Sabó	Tipo	Orientação	Material do Lábio
6,8	22,00	7,0	02166	BRG	LI	NBR
7,0	22,50	3,6	02940	BRGO	LI	HNBR
7,9	23,20	3,2/7,2	02743	BRGO	LI	NBR
8,0	16,00	2,3/3,5	02934	GRE ⁽²⁸⁾	LI	NBR
8,0	16,50	2,3	09803	GR	LI	NBR
8,0	16,50	2,3	09829	GR	LI	NBR
8,0	17,00	38,0	03015	GR	LI	NBR
8,0	19,50	2,3	02615	GRE ⁽²³⁾	LI	NBR
8,0	23,20	2,9	02646	BRGO	LI	NBR
8,0	25,25	2,6	02906	BRGO	LI	NBR
8,0	-	2,5	02409	GR	LI	NBR
8,0	-	9,0	02532	BRGE ⁽²¹⁾	LI	NBR
9,0	23,20	3,2	01614	BRGO	LI	NBR
10,0	19,50	2,3	09837	GR	LI	NBR
10,0	24,35	5,5	02170	GR	LI	NBR
10,0	27,10	3,6	09866	BRGO	LI	NBR
12,0	26,80	4,0	02904	GAE	LI	NBR
12,4	23,50	6,1	09881	NG	LI	NBR
12,4	24,50	6,3	09802	NG	LI	NBR
12,4	29,00	7,8	02864	BRGE	LI	NBR
12,4	31,72	3,4	09841	BRGE	LI	NBR
12,4	39,40	4,5	01971	BAGE	LI	NBR
12,4	39,40	5,3	09854	BRGE	LI	NBR
14,2	48,20	4,7	02463	BAGE	LI	NBR
14,8	24,80	2,8	02850	GRE	LI	NBR
15,0	25,00	8,1/19,0	00344	BE	LI	NBR
15,5	28,00	6,0/15,0	02420	BAGE ⁽²⁶⁾	LI	NBR
15,7	48,15	5,3	09855	BRGE	LI	NBR
15,8	35,80	9,2	02613	BRGE ⁽²²⁾	LI	NBR
16,0	26,00	9,0/20,0	02008	BAGE	LI	NBR
16,0	31,10	3,0	02553	NE	LI	NBR
16,0	31,18	7,0	02552	GRB	LI	NBR
17,0	39,70	3,3	02432	GR	LI	NBR
17,0	40,20	4,6	03281	GR	LI	NBR
18,0	40,70	5,3	09906	BRGE	LI	NBR
20,0	27,00	2,0/4,0	02812	GAE	LI	NBR
20,0	31,70	3,3	02620	BRGO	LI	NBR
20,0	31,70	3,3	09843	BRO	LI	NBR
20,0	31,80	3,3/10,1	09811	BRO	LI	NBR
20,0	32,00	2,8	09820	BRGO	LI	NBR
20,0	32,00	3,0	01987	BRGO	LI	NBR
20,0	32,18	3,0	02408	BRGO	LI	NBR
20,0	32,25	3,5	02726	BRGO	LI	NBR
20,0	33,80	32,0	02582	BRGO	LI	NBR
20,0	34,80	3,0	01919	BRGO	LI	NBR
20,0	34,80	3,0	02286	BRGO	LI	FPM
20,0	34,80	3,6	02598	BRGO	LI	NBR
20,0	35,00	7,0/11,0	02022	GRGGO	LI	NBR
20,0	37,00	8,0/11,0	02710	GRGE	LI	NBR
20,0	38,90	3,2	09867	BROE	LI	NBR
20,0	40,40	6,0	09856	BRGE	LI	NBR
20,0	40,95	6,0	09849	BRGE	LI	NBR
20,0	45,25	5,3	09804	BRGO	LI	NBR

Tipos Especiais

Grupo G

Retentores para Vedação Externa

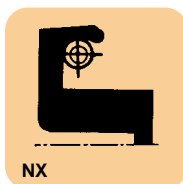
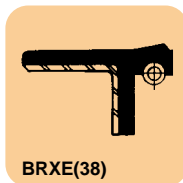

Diâmetro do Eixo	Diâmetro do Alojamento	Altura do Retentor	Número Sabó	Tipo	Orientação	Material do Lábio
5,0	35,00	14,0	01102	NXE	LI	NBR
8,0	35,00	16,0	01826	BRXE ⁽³⁵⁾	LI	NBR
8,0	35,00	13,0	02380	BRXE ⁽³⁵⁾	LI	NBR
12,0	18,00	8,0	07390	GRAGX	LI	NBR
14,7	22,10	7,0	01978	GROX	LI	NBR
16,0	35,00	12,0	00510	BRX	LI	NBR
17,0	40,00	11,0	01799	BRX	LI	NBR
20,9	30,06	12,0	01876	GRXE	LI	NBR
22,0	45,00	12,0	01089	BRX	LI	NBR
39,7	68,15	13,0	01678	GRX ⁽³⁷⁾	LI	NBR
46,0	65,57	11,1	01546	GRX	LI	NBR
48,0	80,00	13,0	02274	BRX	LI	NBR
50,0	65,10	12,0	02518	BRXE ⁽³⁶⁾	LI	NBR
52,4	74,70	8,4	02026	GGGX	LI	NBR
55,0	70,00	12,0	02517	BRXE ⁽³⁶⁾	LI	NBR
57,0	85,00	13,0	02673	BRX	LI	NBR
74,5	80,10	22,0	01874	BRXE	LI	NBR
82,5	114,30	14,3	01185	BAX	LI	NBR
143,0	150,00	27,0	01090	BRXE	LI	NBR
143,3	150,00	39,5	01806	BRXE	LI	NBR

Tipos Especiais

Grupo
H

Tampão

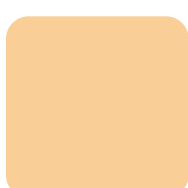
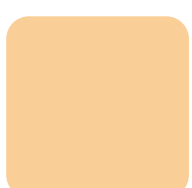
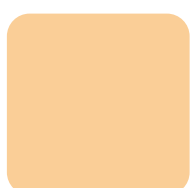
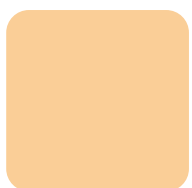
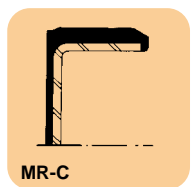
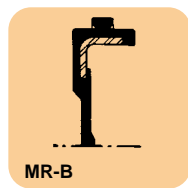
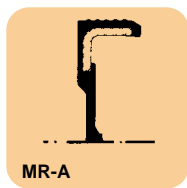
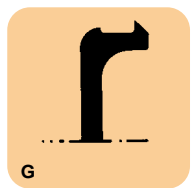

Diâmetro do Eixo	Diâmetro do Alojamento	Altura do Retentor	Número Sabó	Tipo	Figura	Material do Lábio
-	16,00	7,0	10420	MR	C	NBR
-	20,00	4,0	07198	MR	-	NBR
-	20,00	4,0	07313	MR	-	NBR
-	27,50	7,0	10409	MR	A	NBR
-	27,50	7,0	10410	MR	B	NBR
-	28,00	7,0	03301	MRP	-	ACM
-	28,00	7,0	10411	MR	A	NBR
-	28,00	7,0	10412	MR	B	NBR
-	52,00	6,5	07298	MR	-	NBR
-	52,00	8,0	07502	MR	-	NBR
-	68,00	8,5	10415	MRP	A	ACM

Grupo
I

Retentores Especiais

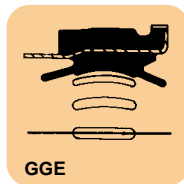
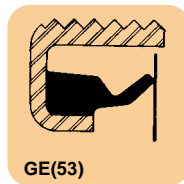
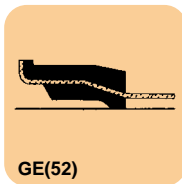
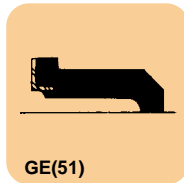
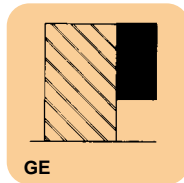
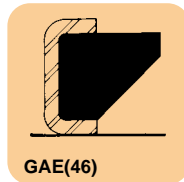
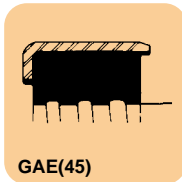
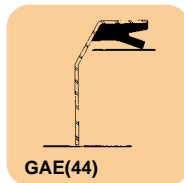
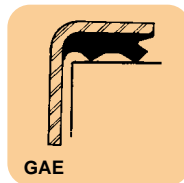
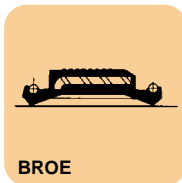
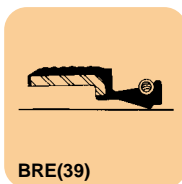
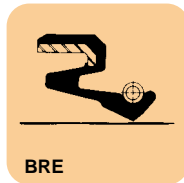
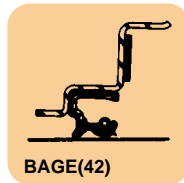
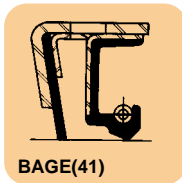
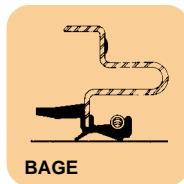
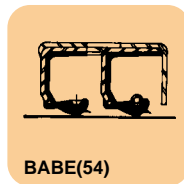
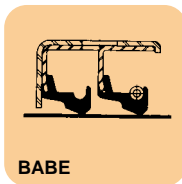

Diâmetro do Eixo	Diâmetro do Alojamento	Altura do Retentor	Número Sabo	Tipo	Orientação	Material do Lábio
2,0	24,50	14,7	10316	MGE	LI	NBR
2,0	25,00	14,7	03038	MGE	LI	NBR
12,0	28,05	8,0	03110	BRGE	LI	NBR
12,5	28,60	9,0	02354	GAE	LI	NBR
16,0	22,00	6,2/9,7	02928	BRE ⁽³⁹⁾	LI	NBR
17,0	28,00	7,0/10,0	01837	BRGE	H	NBR
17,8	30,00	11,0	01818	GAE ⁽⁴⁵⁾	AH	NBR
22,0	42,50	29,5	10145	GGE	LI	NBR
22,2	29,00	6,0	03001	GAE	LI	NBR
26,0	40,00	5,0	02856	GAE ⁽⁵⁰⁾	LI	NBR
26,7	32,70	4,0	02705	GAE	LI	NBR
29,0	35,00	6,0	02815	GAE	LI	NBR
29,0	39,50	8,6	02968	GAE	LI	NBR
29,5	37,00	7,5	02167	GAE ⁽⁴⁹⁾	LI	NBR
29,8	42,30	29,5	10143	GE ⁽⁵²⁾	LI	NBR
30,0	62,90	2,5/20,2	02929	BRGE ⁽⁴⁰⁾	LI	NBR
30,0	64,40	17,0	03260	BRGGE	LI	NBR
30,5	38,00	7,9	01873	GRE	LI	NBR
30,7	36,70	7,0	02704	GAE	LI	NBR
31,0	38,00	6,0	03006	GAE	LI	NBR
35,0	45,15	15,0/24,0	02336	BROE	LI	NBR
35,0	45,60	2,5/5,6	01323	GAE ⁽⁴⁶⁾	LI	NBR
35,0	50,00	7,0/12,4	01896	BRE	H	NBR
35,6	50,75	7,8/9,6	02528	GRL	LI	NBR
37,0	45,00	12,0	02707	GAE	LI	NBR
42,2	53,20	25,5	10144	GE ⁽⁵¹⁾	LI	NBR
45,0	61,90	5,5/10,0	02368	GAE	LI	NBR
52,0	59,00	7,0	03002	GAE	LI	NBR
54,0	81,10	20,7	01933	BABEP ⁽⁵⁴⁾	BI	ACM
54,0	81,10	22,9	01008	BAGEP ⁽⁴¹⁾	LI	ACM
56,0	63,20	11,0	02706	GAE ⁽⁴⁴⁾	LI	NBR
60,2	85,74	22,9	01007	BABEP	LI	ACM
60,3	85,75	22,8	02090	BABE ⁽⁵⁴⁾	BI	NBR
61,5	76,15	7,1	07425	GAGGE	LI	NBR
63,5	102,50	7,0/22,5	02853	BAGEF	H	FPM
82,6	134,55	41,2	02805	BAGE ⁽⁴²⁾	LI	NBR
82,6	134,55	41,2	02019	BAGE ⁽⁴²⁾	LI	NBR
88,9	152,40	30,4	02804	BAGE ⁽⁴²⁾	LI	NBR
88,9	152,40	39,1	02018	BAGE ⁽⁴²⁾	LI	NBR
109,7	140,00	12,0/40,0	01941	GAE ⁽⁴⁷⁾	LI	NBR
111,3	142,85	4,8	01132	GR	LI	NBR
138,0	184,00	12,0/38,0	01925	GRE ⁽⁴³⁾	LI	NBR

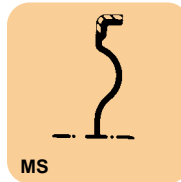
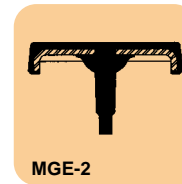
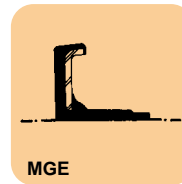

Tipos Especiais

Grupo
J

Arruela para Vedação

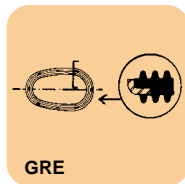
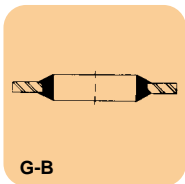
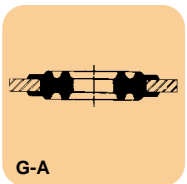

Diâmetro do Eixo	Diâmetro do Alojamento	Altura do Retentor	Número Sabó	Tipo	Figura	Material do Lábio
8,3	-	1,5/1,9	22030	G	B	NBR
8,7	-	0,9/1,6	20180	G	B	NBR
10,7	-	1,5/2,5	01747	G	B	NBR
14,9	-	2,1/2,9	01990	G	B	NBR
17,5	-	1,6	10418	G	A	NBR
27,0	-	2,5/3,3	01991	G	B	NBR



Retentores com Aba no Externo

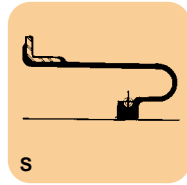
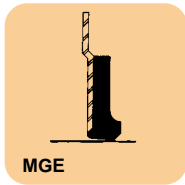
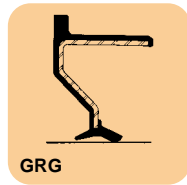
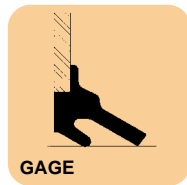
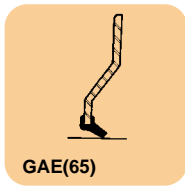
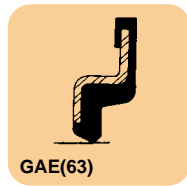
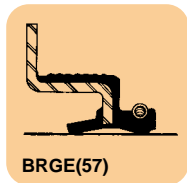
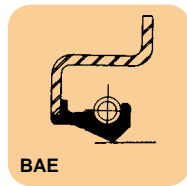

Diâmetro do Eixo	Diâmetro do Alojamento	Altura do Retentor	Número Sabó	Tipo	Orientação	Material do Lábio
15,0	21,00	2,0/14,0	02319	BRGE ⁽⁵⁸⁾	LI	NBR
17,0	39,80	0,6/3,5	00719	MGE	LI	NBR
20,0	30,00	0,9/7,0	00505	BRE	LI	NBR
20,0	40,00	0,9/6,5	01170	BAE	LI	NBR
22,0	32,00	1,9/5,0	02258	GAE ⁽⁶³⁾	LI	NBR
22,1	40,00	12,0/17,0	00224	BRGE ⁽⁵⁵⁾	H	NBR
22,3	35,74	3,7/10,0	02132	BRES	H	MVQ
24,0	62,00	3,0/12,0	01456	BRE	LI	NBR
25,0	38,00	10,5/14,5	02797	BRGEF ⁽⁵⁷⁾	LI	FPM
25,0	52,00	2,0/15,0	02411	GRG	LI	NBR
28,0	38,00	3,0	05183	GAGE	LI	NBR
28,0	40,60	1,0/5,0	02520	GAE ⁽⁶²⁾	LI	NBR
28,0	46,00	3,0	05139	GAGE	LI	NBR
28,2	45,92	0,8/5,5	05052	GAGE	LI	NBR
30,0	61,95	0,9/5,0	03026	GAE	LI	NBR
30,0	72,00	2,5/10,5	01792	BRE	LI	NBR
30,0	72,25	3,0/20,0	02388	GRG	LI	NBR
31,7	44,45	1,5/5,9	02257	GAE ⁽⁶²⁾	LI	NBR
33,0	51,90	3,0/12,0	01849	BAGE	BI	NBR
35,0	48,20	5,0/14,4	02711	GRGE	LI	NBR
35,0	54,90	0,7/14,7	02374	BAGE ⁽⁶¹⁾	BI	NBR
35,0	54,90	9,0/14,7	02836	BAGEF ⁽⁶¹⁾	BI	FPM
38,0	52,00	2,5/8,5	01850	BRGE	LI	NBR
38,0	52,00	3,6/9,0	01219	BRGE	LI	NBR
38,5	45,58	8,0/14,7	02071	BRGE ⁽⁵⁶⁾	LI	NBR
39,5	54,50	3,0/16,0	01276	GRE	LI	NBR
40,0	52,00	2,8/8,5	02212	BRGE	LI	NBR
40,0	90,15	3,0/20,0	02410	GRG	LI	NBR
40,1	52,00	1,9/7,7	01988	BRGE	LI	NBR
40,1	52,00	2,5/8,5	00904	BRGE	LI	NBR
40,1	52,00	3,5/9,0	00979	BRGE	LI	NBR
43,4	56,00	1,6/9,0	01943	BAGEP	H	ACM
44,0	65,00	2,5/12,2	01918	BRGE	LI	NBR
44,8	61,30	2,7/12,0	00097	BRE	LI	NBR
45,0	58,25	5,0/18,0	01289	GRE	LI	NBR
46,0	65,50	7,0/8,5	01764	BAGG	LI	NBR
46,3	66,60	0,8/6,7	02305	BAG	BI	NBR
47,0	63,00	5,6/11,2	02581	GAE ⁽⁶⁴⁾	LI	NBR
47,6	68,00	14,0	02516	BRGEP	LI	ACM
47,6	68,00	0,9/10,4	02960	BAGEP ⁽⁶⁰⁾	H	ACM
49,2	63,50	1,5/7,4	01881	GOE	LI	NBR
50,0	110,15	3,0/23,0	02435	GRG	LI	NBR
50,8	58,80	3,6/4,6	02819	GAE ⁽⁶²⁾	LI	NBR
68,3	85,55	5,3/14,8	00177	GE	LI	NBR

Tipos Especiais

Grupo
L

Retenores Integrados

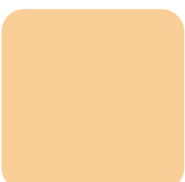
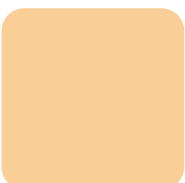
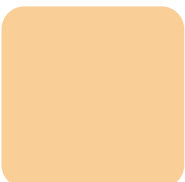
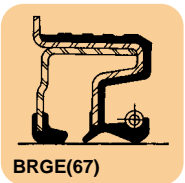
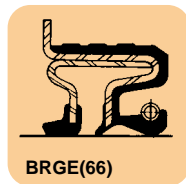
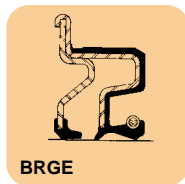
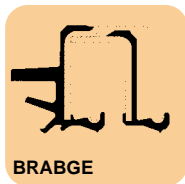

Diâmetro do Eixo	Diâmetro do Alojamento	Altura do Retenor	Número Sabó	Tipo	Orientação	Material do Lábio
40,0	70,00	13,0/20,0	07481	BRABGEF	BI	FPM/ACM
47,8	68,00	0,9/14,0	02516	BRGEP ⁽⁶⁶⁾	H	ACM
57,2	82,60	0,9/14,0	02512	BRGE ⁽⁶⁷⁾	AH	NBR/ACM
60,3	92,00	2,5/14,0	02561	BRGEP	H	ACM
63,5	98,45	3,0/15,0	02686	BRGEP ⁽⁶⁷⁾	H	ACM
69,8	98,40	2,5/11,5	02562	BRGEP	H	ACM
76,3	125,35	3,0/19,5	02687	BRGEP ⁽⁶⁷⁾	H	ACM

Tipos Especiais



Retentores com Pista Própria

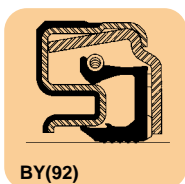
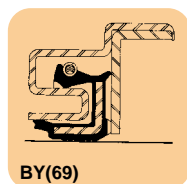
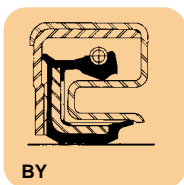
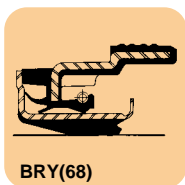
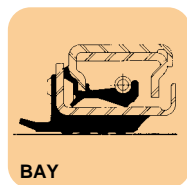

Diâmetro do Eixo	Diâmetro do Alojamento	Altura do Retentor	Número Sabó	Tipo	Orientação	Material do Lábio
30,0	52,00	10,0	02744	GY	LI	NBR
40,0	69,00	15,4	07217	BY	BI	NBR
59,9	85,40	22,9	02874	BAY	BI	NBR
82,5	114,30	12,7	07375	BY	BI	NBR
82,5	114,30	12,7	07439	BYF	BI	FPM
82,5	114,30	12,7	01923	BY	BI	NBR
98,4	144,54	16,0	02485	BY	BI	NBR
98,4	144,00	16,0	07416	BY	BI	NBR
106,5	140,00	15,0	02894	BY	BI	NBR
121,1	160,00	35,0	07340	BAYF	BI	FPM
121,1	160,20	35,0	02713	BRV	BI	NBR
127,0	158,75	16,0	02496	BY	BI	NBR
142,8	182,50	24,0	02490	BY ⁽⁶⁹⁾	BI	NBR

Tipos Especiais

Grupo
N

Só Borracha

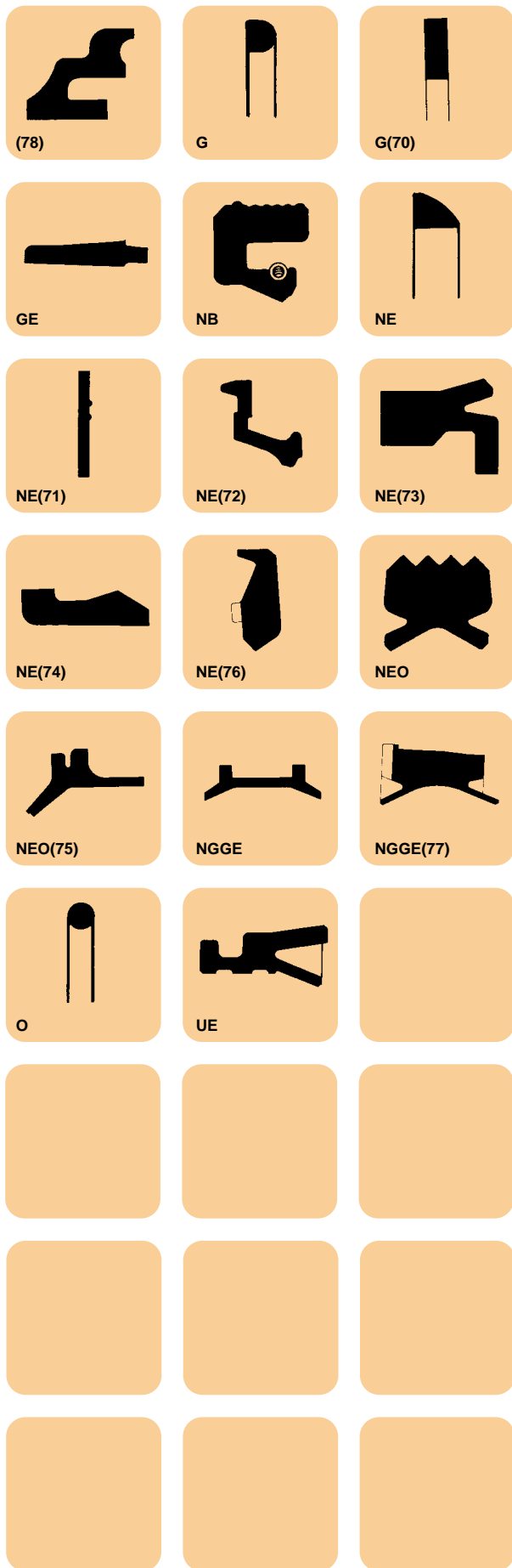

Diâmetro do Eixo	Diâmetro do Alojamento	Altura do Retentor	Número Sabô	Tipo	Orientação	Material do Lábio
-	69,80	3,0	20163	NE ⁽⁷¹⁾	LI	NBR
4,0	12,00	8,0	20172	NE ⁽⁷³⁾	LI	NBR
4,0	10,50	3,2	20072	G	LI	NBR
7,2	19,25	3,0	20148	G ⁽⁷⁰⁾	LI	NBR
13,2	29,25	3,0	20147	G ⁽⁷⁰⁾	LI	NBR
17,0	21,50	15,0	20205	NEF ⁽⁷⁴⁾	LI	FPM
17,5	25,00	4,8	20063	G ⁽⁷⁰⁾	LI	NBR
19,7	31,75	18,0	20145	GE	LI	NBR
22,9	34,80	26,7	20144	G	LI	NBR
24,3	39,50	9,2	00524	NEO	LI	NBR
31,4	49,53	16,8	03232	NE	LI	CR
33,0	44,50	5,3	02011	NEF	LI	FPM
47,0	56,75	14,0	01891	NEO ⁽⁷⁵⁾	LI	NBR
157,0	170,30	19,5	20210	UE	LI	NBR

Tipos Especiais

Grupo 0

Retentores Fixados por Parafusos

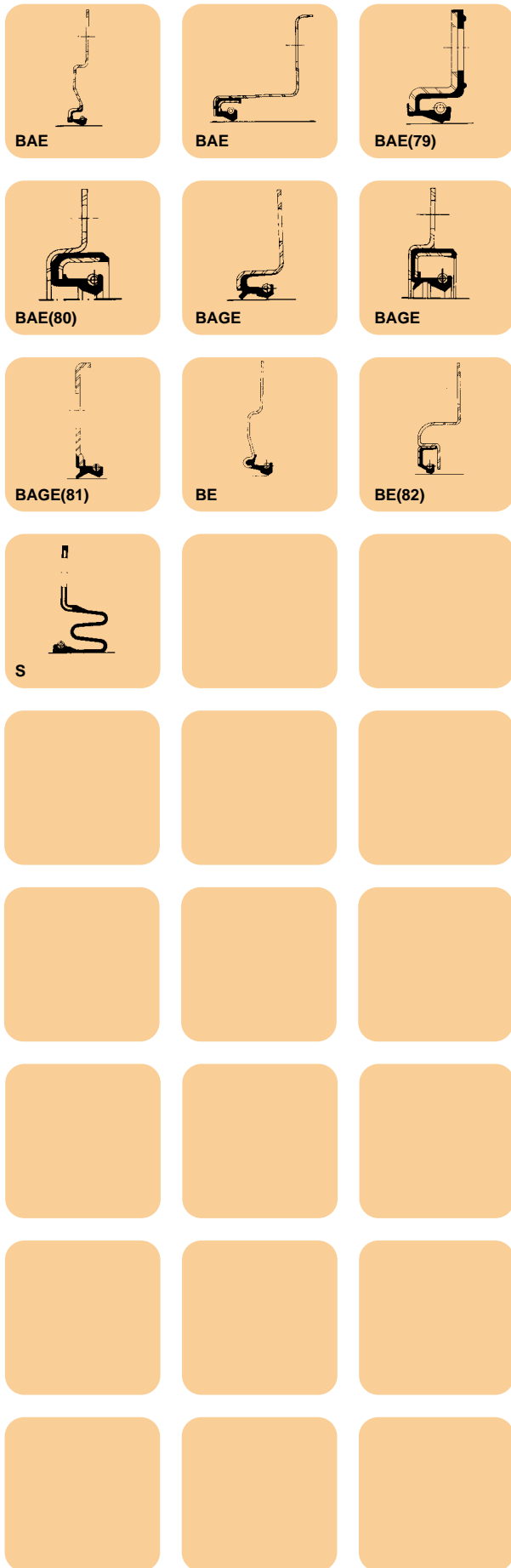

Diâmetro do Eixo	Diâmetro do Alojamento	Altura do Retentor	Número Sabó	Tipo	Orientação	Material do Lábio
19,0	50,80	1,7/7,7	02716	BAEF ⁽⁷⁰⁾	LI	FPM
50,8	115,90	14,3	00039	BAGE	LI	NBR
50,8	116,02	16,2	01595	BAGE	LI	NBR
52,0	114,00	13,0	01794	BAGE ⁽⁸⁰⁾	LI	NBR
58,0	120,00	12,8	01795	BAGE ⁽⁸⁰⁾	LI	NBR
60,3	149,40	8,3	02098	BAE	BI	NBR
60,3	155,50	7,4	02333	BAE	BI	NBR
60,5	149,40	11,5	01028	BE	LI	NBR
63,6	155,60	12,0	02033	BAE	BI	NBR
79,0	210,00	25,4	00461	BE ⁽⁸²⁾	LI	NBR
93,0	157,00	7,4	02299	BAGE ⁽⁸¹⁾	LI	NBR
150,8	229,40	28,6	02044	BAGE	BI	NBR
190,5	285,80	48,7	02065	BAE	BI	NBR

Tipos Especiais

Grupo
P

Retentores de Metal e Ferro

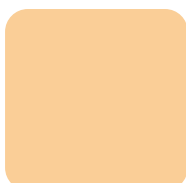
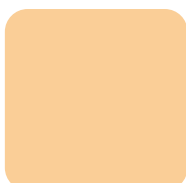
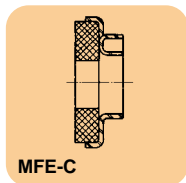
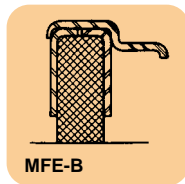
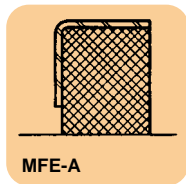
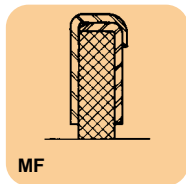

Diâmetro do Eixo	Diâmetro do Alojamento	Altura do Retentor	Número Sabó	Tipo	Figura	Material do Lábio
19,0	26,80	6,0	01692	MFE	A	Metal/ Feltro
25,4	-	6,5/10,0	01651	MFE	C	Metal/ Feltro
44,5	66,60	12,7	01913	MF	-	Metal/ Feltro
60,0	75,00	5,0	01821	MFE	A	Metal/ Feltro
62,7	84,05	8,0/12,7	00096	MFE	B	Metal/ Feltro

Tipos Especiais

Grupo
Q

Retentores de Feltro

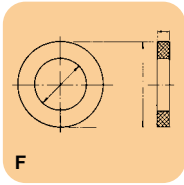

F

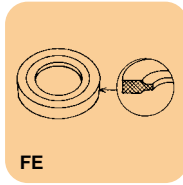

FE

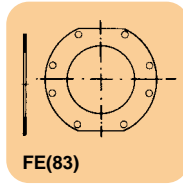

FE(83)



GF



Diâmetro do Eixo	Diâmetro do Alojamento	Altura do Retentor	Número Sabó	Tipo	Orientação	Material do Lábio
17,5	-	3,2	01402	F	-	Feltro
23,6	38,10	9,6	00287	GF	-	Feltro
26,1	36,07	8,0	00757	F	-	Feltro
31,0	45,20	6,4	01680	F	-	Feltro
42,0	-	10,0	01534	F	-	Feltro
45,0	58,00	6,0	00860	F	-	Feltro
58,4	-	10,2	01104	FE	-	Feltro
60,0	77,00	7,0	00858	F	-	Feltro
104,8	-	3,2	01632	FE ⁽⁸³⁾	-	Feltro

Tipos Especiais

Grupo
R

Retenores Estampados

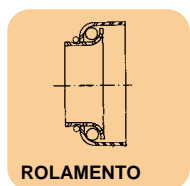
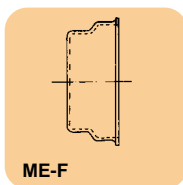
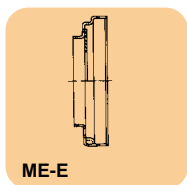
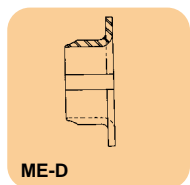
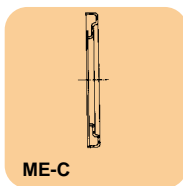
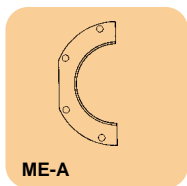
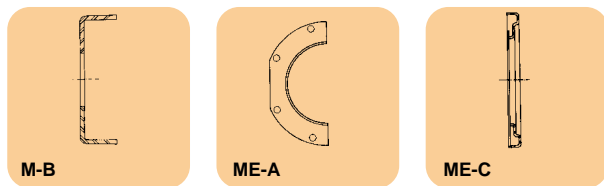

Diâmetro do Eixo	Diâmetro do Alojamento	Altura do Retentor	Número Sabó	Tipo	Figura	Material do Lábio
28,5	30,70	6,5	10141	ME	D	Estamp.
46,0	51,70	20,0	10026	ME	C	Estamp.
57,3	90,10	7,5	10131	ME	C	Estamp.
111,3	174,50	4,0	01633	ME	A	Estamp.
114,0	174,40	16,0	01466*	MFBE	-	Estamp.

* 01466 MFBE – Conjunto composto de:
 (1) 01132 GR
 (2) 01632 FE
 (3) 01633 ME



Retentores em PTFE

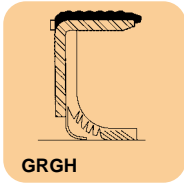
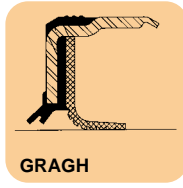

Diâmetro do Eixo	Diâmetro do Alojamento	Altura do Retentor	Número Sabó	Tipo	Orientação	Material do Lábio
40,0	62,00	7,4	05199	GRGH	H	ACM/PTFE
59,3	76,20	8,3	05229	GRAGGH	H	ACM/PTFE
104,0	128,00	11,0/14,0	05278	GHSI	AH	ACM/PTFE
110,0	130,00	9,3	05230	GRAGH	AH	ACM/PTFE
130,0	150,00	12,0	05287	GRGH	AH	ACM/PTFE

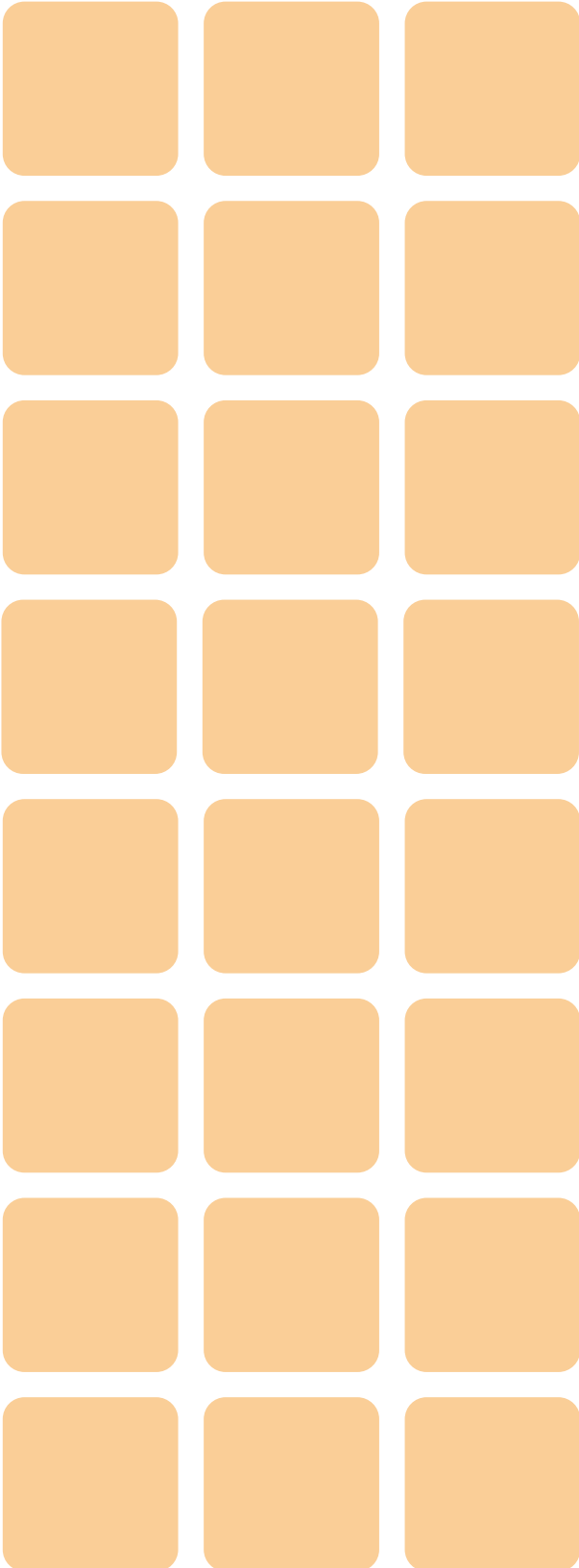

Tipos Especiais

Grupo
T

Sistema de Vedação

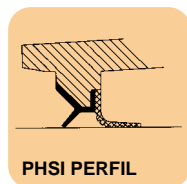
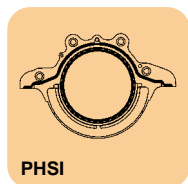
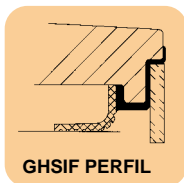
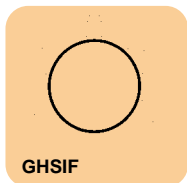
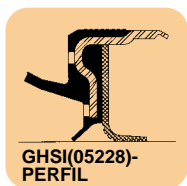
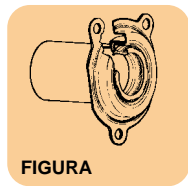

Diâmetro do Eixo	Diâmetro do Alojamento	Altura do Retentor	Número Sabô	Tipo	Orientação	Material do Lábio
21,8	-	48,4	02952	BAGEP	H	ACM
21,8	-	48,4	07240	BAGEP	H	ACM
28,0	-	54,5	07148	BRAGEP	H	ACM
79,0	-	21,0	05338	PHSI	AH	PTFE
85,0	-	13,0	05502	GHSI	AH	ACM/ PTFE
85,0	-	13,0	05210	GHSI	AH	ACM/ PTFE
103,0	128,00	14,0	05228	GHSI	AH	ACM/ PTFE
99,5	108,00	19,0	05239	GHSIF	AH	ACM/ PTFE
39,9	68,90	15,4	07300	SIST. BY	BI	NBR

Tipos Especiais



Retentores Tipo "S"

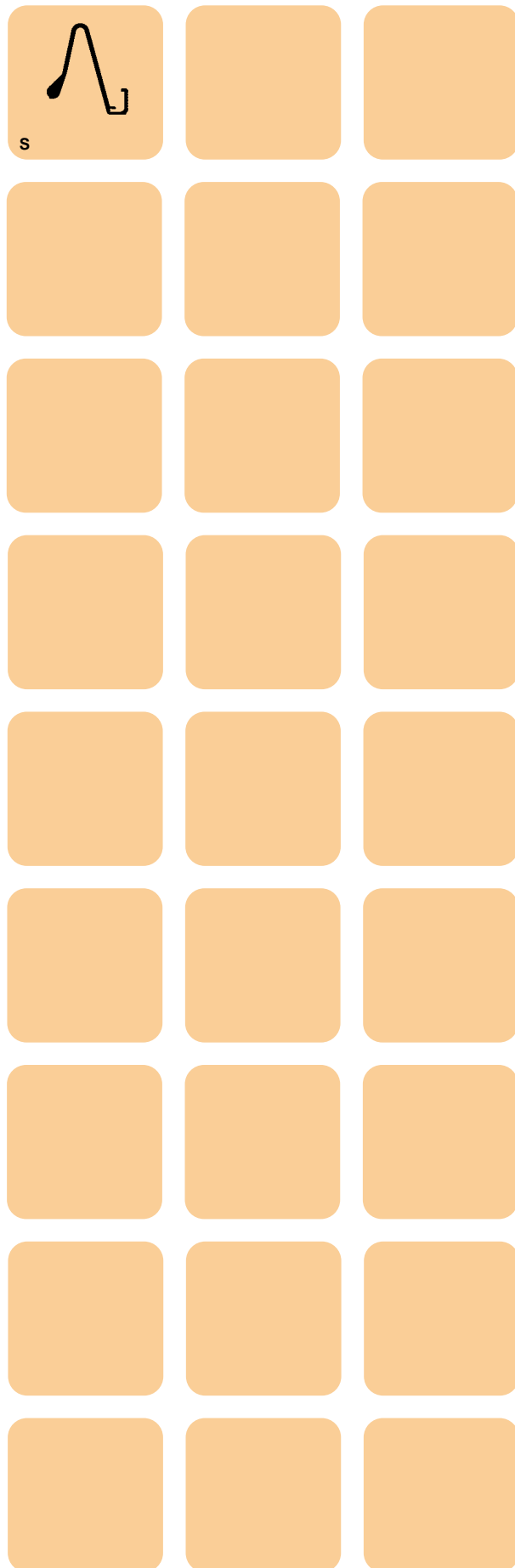

Diâmetro do Eixo	Diâmetro do Alojamento	Altura do Retentor	Número Sabó	Tipo	Orientação	Material do Lábio
14,2	50,70	10,7/46,1	02020	S	LI	NBR
17,5	50,00	21,5	07266	S	LI	NBR
17,5	50,00	21,5	07679	S	LI	NBR
21,9	52,80	2,0/21,6	10416	S	LI	CR
30,0	111,00	20,7	10413	S	LI	NBR

Tipos Especiais

Número Sabó	Tipo	Diâmetro do Eixo	Diâmetro do Alojamento	Altura do Retentor	Grupo
00001	BE	81,0	117,50	14,5/19,0	B
00002	B	81,0	117,50	14,3	
00003	BE	79,4	115,85	10,1/30,5	B
00004	B	52,4	72,10	11,4	
00005	B	52,4	80,95	11,5	
00006	BA	53,8	77,70	12,7	
00007	B	98,5	144,45	19,0	
00008	B	79,4	117,40	14,3	
00009	BR	35,0	60,25	12,7	
00010	GA	58,7	84,05	9,5	
00012	BA	44,8	61,30	12,0	
00013	B	57,2	76,10	12,7	
00013	BRG	57,3	76,20	12,7	
00014	BGO	57,2	92,00	18,0	
00015	GA	47,6	75,30	6,4	
00016	B	39,7	61,20	12,7	
00017	B	31,8	42,80	9,5	
00018	BE	92,0	123,75	15,0/19,0	B
00019	BR	38,1	63,50	12,7	
00021	B	60,3	88,40	11,0	
00022	BAE	43,7	71,90	9,0/21,6	B
00023	BAE	43,7	72,10	9,0/21,6	B
00025	B	85,7	119,00	12,7	
00026	GA	35,0	61,80	7,5	
00028	B	31,7	50,70	11,0	
00029	BAE	39,7	80,20	6,4/15,0	B
00030	B	66,7	92,00	12,0	
00033	B	35,0	63,50	12,7	
00037	B	53,9	73,00	12,7	
00039	BAGE	50,8	115,90	14,3	O
00042	BR	135,0	189,95	15,0	
00043	BA	100,0	130,00	13,0	
00044	BR	62,0	85,00	13,0	
00045	B	95,0	125,00	13,0	
00046	BR	75,0	95,10	13,0	
00047	B	52,0	72,00	12,0	
00047	BAGF	52,0	72,00	12,0	
00048	BR	50,8	76,25	12,7	
00049	B	38,1	60,30	12,7	
00049	BAG	38,1	60,30	12,7	
00049	BAGE	38,1	60,30	12,7/17,7	B
00051	BRP	65,0	90,00	10,0	
00054	BR	28,6	39,70	9,5	
00056	B	28,6	46,55	11,3	
00058	B	65,8	88,40	12,7	
00063	BRG	45,0	62,00	10,0	
00065	GA	62,0	92,00	9,5	
00066	BAG	39,4	62,00	14,0	
00069	B	44,5	69,80	12,7	
00070	BA	58,7	85,00	8,0	
00072	BA	49,2	69,90	9,5	
00078	BAE	49,2	80,10	8,1/22,2	B
00081	B	69,9	98,45	12,7	

Número Sabó	Tipo	Diâmetro do Eixo	Diâmetro do Alojamento	Altura do Retentor	Grupo
00083	B	41,3	61,90	12,0	
00085	B	87,3	120,80	14,3	
00087	B	72,2	100,00	12,7	
00089	B	9,5	25,35	9,5	
00092	BGOE	47,6	70,65	14,4/16,7	B
00093	BA	53,9	76,15	12,7	
00096	MFE	62,7	84,05	8,0/12,7	P
00097	BRE	44,8	61,30	2,7/12,0	K
00098	B	73,0	95,20	12,7	
00099	B	119,0	146,00	14,3	
00100	B	22,2	38,10	9,5	
00101	B	44,5	63,55	12,7	
00109	B	57,2	80,00	12,7	
00114	GR	31,7	42,85	5,0	
00116	B	73,0	101,60	12,7	
00117	GR	28,6	39,75	4,7	
00118	BAG	22,0	35,00	10,0	
00119	GA	15,9	23,80	4,8	
00120	BAG	63,5	88,90	12,7	
00121	BA	27,0	41,80	7,1	
00122	GA	28,5	36,50	7,0	
00123	B	101,6	126,90	12,7	
00125	B	114,3	139,65	14,3	
00127	B	29,4	46,45	10,0	
00128	BR	44,5	66,65	12,7	
00129	BR	12,7	25,40	9,5	
00131	BR	30,0	47,00	10,0	
00133	BR	41,3	63,55	12,7	
00134	B	81,0	114,20	12,0	
00136	BA	35,0	62,00	12,0	
00141	BA	25,4	38,05	10,0	
00145	B	25,4	46,45	9,5	
00146	B	57,2	79,30	12,7	
00150	BA	22,2	33,15	10,3	
00155	B	47,6	69,80	12,7	
00156	B	15,9	28,55	9,5	
00156	BRO	15,9	28,55	9,5	A
00157	BA	49,2	63,50	9,5	
00158	B	19,0	38,05	10,0	
00159	BR	19,0	35,00	10,0	
00160	BR	165,0	190,00	12,9	
00161	BRG	48,0	72,00	10,0	
00162	BR	50,0	71,85	12,0	
00164	BAG	65,0	90,00	13,0	
00164	BR	65,0	90,00	13,0	
00166	BR	39,7	62,00	12,0	
00168	BAE	60,3	91,40	6,4/15,3	B
00170	BA	32,0	44,25	9,0	
00177	GE	68,3	85,55	5,3/14,8	K
00181	BE	73,0	104,70	9,6/20,6	B
00188	BA	57,3	84,00	8,0	
00191	BR	25,0	41,10	9,5	
00198	BA	8,0	17,45	8,0	

Número Sabó	Tipo	Diâmetro do Eixo	Diâmetro do Alojamento	Altura do Retentor	Grupo
00203	BR	38,1	54,10	11,0	
00211	BGO	149,2	181,00	12,7	
00214	BR	35,0	53,95	11,0	
00218	B	36,5	57,05	12,7	
00219	BR	44,0	76,10	12,7	
00220	BAE	47,8	60,90	6,4	B
00221	B	79,4	104,65	12,7	
00222	BAG	44,7	61,20	9,5	
00223	BR	60,0	80,00	10,0	
00224	BRGE	22,1	40,00	12,0/17,0	K
00224	BRGP	22,1	40,00	12,0/17,0	A
00224	BRGP	22,1	40,00	12,0/17,0	A
00228	BAG	68,0	90,00	10,0	
00229	B	49,2	80,90	11,0	
00231	BRG	53,9	81,10	12,0	
00248	BR	142,9	171,05	14,3	
00250	BR	120,7	146,05	12,5	
00250	BRP	120,7	146,05	12,5	
00254	BAO	38,1	57,10	11,0	A
00258	GA	35,0	57,90	6,4	
00262	B	28,0	47,00	10,0	
00262	BA	28,0	47,00	10,0	
00264	BR	47,7	62,10	8,0	
00265	BR	40,0	56,10	12,0	
00266	BR	25,0	47,00	10,0	
00268	BR	190,0	220,00	14,8	
00268	BRP	190,0	220,00	14,8	
00269	BAGS	75,0	100,00	12,0/13,0	
00269	BR	75,0	100,00	12,0	
00272	BRG	45,0	60,00	7,0	
00273	B	57,2	85,00	12,7	
00274	BGO	50,8	81,00	11,9	
00276	B	44,5	73,00	12,0	
00283	BR	25,4	36,40	6,4	
00284	BR	35,0	55,50	6,4	
00285	BA	27,0	38,10	6,4	
00286	BR	15,9	25,40	4,5	
00287	GF	23,6	38,10	9,6	Q
00288	BR	42,0	56,00	7,0	
00289	BA	12,0	22,00	7,0	
00291	B	49,2	76,05	12,7	
00291	BR	49,2	76,05	12,7	
00293	BR	14,3	28,50	6,4	
00294	BR	22,0	35,00	6,7	
00300	B	89,0	114,30	11,5	
00302	B	46,0	62,00	7,0	
00305	BAG	60,0	78,05	8,8	
00309	B	127,0	158,70	12,7	
00310	B	127,0	165,10	16,0	
00311	B	12,7	28,50	9,5	
00321	BA	57,2	82,50	12,7	
00322	BA	33,3	46,40	9,5	
00323	BGO	74,6	101,60	17,4	

Número Sabó	Tipo	Diâmetro do Eixo	Diâmetro do Alojamento	Altura do Retentor	Grupo
00327	BF	25,4	44,50	14,3	A
00329	BA	19,0	28,50	6,4	
00334	BAG	60,3	92,00	12,0	
00334	BAGE	60,3	92,00	12,0/18,0	B
00338	BGO	19,0	31,85	9,5	
00342	GAG	17,0	28,55	6,4	A
00343	BR	31,7	44,50	8,0	
00344	BE	15,0	25,00	8,1/19,0	D
00357	B	76,2	101,65	12,0	
00357	BA	76,2	101,65	12,0	
00358	BR	30,0	50,00	10,0	
00359	BR	45,0	65,00	10,0	
00360	BA	20,0	40,00	10,00	
00361	BA	42,0	62,00	12,0	
00366	B	92,0	126,85	12,7	
00368	BAG	47,6	62,70	11,1	
00369	BR	66,7	88,90	12,7	
00371	B	60,3	85,00	12,0	
00373	GA	39,1	62,20	6,4	
00375	BA	15,9	35,00	10,0	
00376	B	69,8	95,20	12,7	
00377	BB	76,2	101,60	19,0	A
00378	B	63,5	89,90	12,0	
00379	BR	66,7	95,25	12,7	
00405	B	47,6	66,55	12,7	
00420	BR	125,0	150,10	13,0	
00421	BAGG	73,0	101,60	11,5	A
00423	BR	70,0	100,00	12,0	
00434	B	66,7	112,65	11,0	
00436	B	54,0	79,35	12,7	
00436	BAG	54,0	79,35	12,7	
00436	BAGE	54,0	79,35	12,7/19,0	B
00439	BR	100,0	162,10	15,0	
00442	BR	92,1	123,95	15,8	
00448	BA	25,4	34,90	6,4	
00455	BA	30,2	47,00	8,0	
00456	BA	57,0	69,80	6,4	
00459	BR	55,0	80,00	10,0	
00460	BR	62,0	85,00	10,0	
00461	BE	79,0	210,00	25,4	O
00463	BR	25,0	52,00	10,0	
00466	B	79,4	109,90	13,0	
00468	B	50,8	69,80	12,7	
00469	B	25,0	40,00	10,0	
00470	GA	38,1	50,75	5,5	
00474	GAE	60,2	84,05	8,0/12,7	B
00477	BA	32,0	57,05	9,5	
00479	BR	38,0	52,00	10,0	
00479	BRG	38,0	52,00	10,0	
00480	BA	82,0	105,00	13,0	
00482	GAF	7,8	14,60	4,8	
00484	BA	30,0	50,05	12,0	
00485	BA	35,0	47,00	7,0	

Número Sabó	Tipo	Diâmetro do Eixo	Diâmetro do Alojamento	Altura do Retentor	Grupo
00486	BA	38,0	50,00	7,0	
00490	BR	70,0	90,00	13,0	
00491	B	105,0	130,00	13,0	
00492	BA	35,0	56,05	12,0	
00495	BA	32,0	45,00	7,0	
00496	BRG	18,0	30,00	7,0	
00497	BRG	90,0	120,00	13,0	
00498	BR	55,0	80,00	13,0	
00499	BR	25,0	50,10	10,0	
00500	BAG	68,0	90,00	13,0	
00500	BAGF	68,0	90,00	13,0	
00500	BAGP	68,0	90,00	13,0	
00501	BR	60,0	75,05	8,0	
00502	BR	140,0	170,00	13,0	
00503	BR	28,0	52,10	10,0	
00504	BGO	80,0	100,00	13,0	
00505	BR	20,0	30,00	7,0	
00505	BRE	20,0	30,00	0,9/7,0	K
00506	BR	25,0	43,05	10,0	
00508	BA	17,0	28,00	7,0	
00508	BAG	17,0	28,00	7,0	
00509	BR	45,0	72,00	12,0	
00510	BRX	16,0	35,00	12,0	G
00514	BR	115,0	140,00	13,0	
00515	GA	15,0	30,00	5,0	
00516	B	110,0	139,95	13,0	
00516	BG	110,0	139,95	13,0	
00517	BR	60,0	90,00	10,0	
00519	BA	31,0	41,00	9,5	
00520	BR	35,0	47,05	10,0	
00521	BR	42,0	62,10	10,0	
00522	BRG	48,0	72,10	7,0	
00524	NEO	24,3	39,50	9,2	N
00527	B	48,0	65,00	10,0	
00533	BA	42,8	68,15	10,7	
00536	B	108,0	133,25	12,0	
00541	B	14,3	28,50	9,5	
00546	BR	119,0	162,10	15,0	
00547	B	59,5	85,60	12,0	
00554	BA	44,5	79,90	11,1	
00556	GB	59,9	85,50	17,5	A
00561	BAG	42,0	64,90	12,0	
00563	BR	54,0	72,00	8,0	
00564	BR	42,8	63,35	9,5	
00566	BA	48,0	62,00	8,0	
00569	B	19,0	31,70	6,4	
00569	BR	19,0	31,70	6,4	
00572	BR	22,3	34,95	6,4	
00573	B	74,0	114,00	11,0	
00577	BGOP	89,0	111,10	12,7	
00581	BR	28,6	39,65	6,4	
00586	BRG	50,9	69,80	9,5	
00588	B	44,5	68,15	12,7	

Número Sabó	Tipo	Diâmetro do Eixo	Diâmetro do Alojamento	Altura do Retentor	Grupo
00593	B	82,0	104,70	14,3	
00604	BR	43,0	62,00	10,0	
00607	B	28,2	43,00	9,1	
00608	B	17,8	35,00	9,5	
00609	BR	75,0	100,00	10,0	
00610	BR	80,0	100,00	10,0	
00612	BR	84,0	110,05	16,0	
00615	BR	36,0	56,00	10,0	
00616	BR	102,0	130,00	13,0	
00618	BAG	85,0	110,00	14,0	
00620	B	55,0	75,00	12,0	
00626	BGO	41,1	62,00	16,0	
00630	B	50,8	73,00	12,7	
00631	B	101,6	130,05	14,3	
00634	BAG	28,6	44,50	11,0	
00642	B	88,9	126,90	12,7	
00644	B	82,5	107,85	11,9	
00644	BGO	82,5	107,85	11,9	
00649	B	136,5	168,25	15,9	
00649	BGO	136,5	168,25	15,9	
00650	B	106,4	126,90	12,0	
00651	B	66,7	88,35	12,7	
00652	BG	63,5	88,90	17,8	
00653	B	50,0	69,60	12,7	
00660	B	50,8	80,00	12,7	
00674	B	47,7	72,95	12,0	
00688	BAP	120,0	140,00	13,0	
00692	B	41,3	66,55	12,7	
00694	B	35,0	53,90	9,5	
00695	GB	44,5	85,60	16,0	A
00701	B	30,0	50,75	11,0	
00708	BR	49,2	65,00	8,0	
00709	BR	25,0	44,90	5,0	
00712	BR	20,0	32,00	6,0	
00713	GA	28,0	34,90	5,0	
00714	BA	19,0	41,25	8,0	
00715	BA	20,0	34,95	6,0	
00716	B	14,3	25,40	9,5	
00719	MGE	17,0	39,80	0,6/3,5	K
00726	BR	16,3	24,00	7,0	
00734	BR	44,5	57,15	9,4	
00735	B	57,1	80,00	13,0	
00737	BA	88,0	110,00	13,0	
00744	BBO	104,8	139,60	14,3	A
00745	BGO	18,7	34,90	8,7	
00749	BA	44,5	54,00	4,8	
00752	BA	50,8	79,90	10,0	
00757	F	26,1	36,07	8,0	Q
00758	BR	35,0	52,10	12,0	
00760	BR	20,0	35,00	10,0	
00761	BR	22,0	40,00	7,0	
00762	BR	31,0	47,00	7,0	
00763	BR	24,0	47,00	7,0	

Número Sabó	Tipo	Diâmetro do Eixo	Diâmetro do Alojamento	Altura do Retentor	Grupo
00764	BA	10,0	30,00	7,0	
00766	BA	15,0	30,00	8,0	
00767	BA	20,0	31,95	5,0	
00768	B	25,4	38,00	8,0	
00768	BGO	25,4	38,00	8,0	
00769	BA	22,0	31,85	5,0	
00770	B	25,0	62,00	10,0	
00771	BA	28,5	50,70	10,0	
00772	BA	30,0	55,00	12,0	
00774	B	31,7	50,70	9,5	
00775	BA	44,0	79,90	12,0	
00776	BA	55,0	101,60	10,0	
00780	BR	125,0	160,00	12,0	
00784	BR	19,0	35,00	7,0	
00785	BA	26,0	43,00	10,0	
00788	BAG	25,0	35,00	10,0	
00789	BA	35,0	50,00	10,0	
00789	BR	35,0	50,00	10,0	
00790	BR	15,0	24,00	7,0	
00793	BA	55,0	90,00	10,0	
00795	BR	16,0	30,00	10,0	
00796	BR	16,0	32,00	7,0	
00797	BR	36,0	54,00	7,0	
00798	BA	19,0	31,90	7,0	
00800	BA	35,0	62,00	9,5	
00801	BR	32,0	52,10	10,0	
00803	BAG	110,0	130,00	13,0	
00803	BAS	110,0	130,00	13,0	
00803	BRGS	110,0	130,00	13,0	
00804	BR	55,0	75,00	10,0	
00805	BGO	62,0	85,00	11,9	
00807	BA	6,4	16,05	6,4	
00810	BA	30,0	40,00	8,0	
00813	BA	30,0	42,95	9,5	
00813	BAG	30,0	42,95	9,5	
00815	BR	22,0	42,00	10,0	
00817	BR	30,0	56,00	12,0	
00818	BR	60,0	80,00	13,0	
00819	BR	78,0	110,00	13,0	
00821	BR	19,0	31,80	6,4	
00822	BA	35,0	45,00	7,0	
00824	B	30,0	52,00	12,0	
00828	BR	17,0	35,00	10,0	
00829	BR	24,0	38,00	9,0	
00832	BR	30,0	45,00	12,0	
00834	BR	50,0	72,08	10,0	
00837	B	40,0	70,00	12,0	
00838	B	53,0	75,00	12,0	
00839	BR	32,0	50,00	8,0	
00843	B	52,4	69,80	12,7	
00844	B	25,4	44,45	8,3	
00847	BAG	30,0	42,00	7,0	
00848	GA	47,5	76,05	9,5	

Número Sabó	Tipo	Diâmetro do Eixo	Diâmetro do Alojamento	Altura do Retentor	Grupo
00849	BA	46,3	66,60	6,4	
00853	BR	17,0	35,00	7,0	
00858	F	60,0	77,00	7,0	Q
00860	F	45,0	58,00	6,0	Q
00866	BR	70,0	100,00	10,0	
00867	BR	52,0	80,05	10,0	
00871	BGO	39,7	68,15	11,1	
00877	BR	44,5	60,30	9,5	
00879	BR	35,0	52,30	9,5	
00880	BR	40,0	56,00	8,0	
00888	GA	19,0	25,40	3,2	
00891	BRG	69,8	92,00	14,2	
00893	BA	75,0	90,00	12,0	
00897	BR	40,0	60,00	12,0	
00900	BR	80,0	110,00	12,0	
00903	BA	65,0	88,45	12,7	
00904	BRGE	40,1	52,00	2,5/8,5	K
00906	BR	70,0	85,00	8,0	
00907	BR	63,5	76,10	9,5	
00909	BR	20,0	47,10	10,0	
00911	BRG	30,0	50,00	11,0	
00912	BRG	35,0	52,00	12,0	
00913	BR	40,0	80,10	10,0	
00916	BA	15,0	28,00	7,0	
00918	BR	20,0	36,00	10,0	
00919	BR	56,0	85,00	13,0	
00922	BR	20,0	40,30	10,0	
00924	BR	40,0	57,00	12,0	
00925	BA	25,0	42,00	8,0	
00926	BR	65,0	85,10	10,0	
00932	BR	28,6	39,75	7,0	
00934	B	25,4	41,25	9,5	
00937	B	22,2	34,95	8,0	
00937	BAG	22,2	34,85	8,0	
00937	BG	22,2	34,95	8,0	
00946	BR	50,0	70,00	10,0	
00947	BR	28,0	47,50	9,5	
00949	BR	30,0	52,00	10,0	
00950	B	28,6	50,30	9,5	
00951	GA	41,3	75,75	6,4	
00952	BR	30,0	52,00	8,0	
00953	BR	20,0	32,10	7,0	
00954	BAE	38,0	50,00	10,0/16,0	A
00955	BAG	22,0	35,00	9,0	
00959	B	19,0	34,90	9,5	
00961	B	28,6	52,30	9,5	
00962	BR	35,0	50,00	8,0	
00962	BRGP	35,0	50,00	8,0	
00963	BAG	20,5	41,20	5,0	
00964	B	55,0	90,00	12,5	
00969	BR	35,0	47,05	9,0	
00974	BA	52,4	76,10	7,9	
00974	GAO	52,4	76,00	7,9	A

Número Sabó	Tipo	Diâmetro do Eixo	Diâmetro do Alojamento	Altura do Retentor	Grupo
00977	BR	60,0	82,00	12,0	
00979	BRGE	40,1	52,00	3,5/9,0	K
00980	BA	16,0	28,00	7,0	
00981	GA	12,7	25,35	6,4	
00989	BAG	19,0	31,75	8,0	
00992	BRG	22,0	40,00	8,0	
00994	BA	20,0	40,00	7,0	
00994	BRG	20,0	40,00	7,0	
00995	BA	38,2	63,50	11,1	
00998	BR	8,5	16,00	6,5	
01004	BAG	35,5	58,20	13,0	
01007	BABEP	60,2	85,74	22,9	I
01008	BAGEP	54,0	81,10	22,9	I
01009	BR	25,4	44,60	6,4	
01012	BGO	54,0	77,75	19,0	
01017	BR	49,0	75,00	11,0	
01019	BR	25,0	38,00	6,4	
01020	B	28,0	50,00	12,0	
01022	BR	28,6	38,00	7,0	
01028	BE	60,5	149,40	11,5	O
01033	BB	38,1	63,45	19,0	A
01035	GR	55,0	68,00	4,0	
01038	B	45,0	85,00	13,0	
01040	BA	33,3	69,40	7,9	
01041	B	35,0	47,55	9,5	
01043	B	94,9	129,95	13,0	
01044	BAG	74,0	90,00	10,0	
01045	BRG	26,0	37,00	7,0	
01046	BAG	40,0	56,00	10,0	
01048	BR	34,5	48,05	8,8	
01049	BRE	46,0	76,20	9,5/12,7	B
01050	BR	60,4	79,35	9,3	
01050	BRGS	60,4	79,35	9,3	
01051	BR	15,0	35,10	10,0	
01058	BR	15,0	35,00	7,0	
01063	BA	30,2	62,00	12,0	
01064	MV	50,8	58,00	11,5	E
01067	BR	10,8	22,20	5,4	
01072	BA	17,0	28,00	6,0	
01072	BR	17,0	28,00	6,0	
01074	BRG	13,0	26,00	9,0	
01076	B	15,0	28,55	8,0	
01077	BBOE	50,0	81,00	18,0/53,0	B
01081	BR	42,0	72,00	12,0	
01089	BRX	22,0	45,00	12,0	G
01090	BRXE	143,0	150,00	27,0	G
01091	GB	73,0	101,65	17,4	A
01093	BR	9,5	19,20	7,0	
01095	BRG	44,5	62,00	11,0	
01097	BR	12,7	30,00	8,0	
01100	BAG	41,1	65,40	13,0	
01102	NXE	5,0	35,00	14,0	G
01103	B	108,0	133,25	9,5	

Número Sabó	Tipo	Diâmetro do Eixo	Diâmetro do Alojamento	Altura do Retentor	Grupo
01103	GB	108,0	133,30	9,5	A
01104	FE	58,4	-	10,2	Q
01107	BR	18,0	40,00	9,0	
01109	BR	40,0	62,00	11,5	
01109	BRG	40,0	62,00	11,5	
01110	BR	19,3	29,10	6,4	
01111	BRGE	46,0	65,50	9,0/13,2	B
01112	BR	22,0	38,05	8,0	
01113	BRG	17,0	35,30	7,0	
01116	BR	40,0	60,00	10,0	
01118	B	25,0	38,00	8,0	
01119	BAG	44,2	71,45	14,8	
01125	BBO	63,5	89,90	22,2	A
01129	GAE	20,0	47,00	10,0/12,7	A
01129	GRO	20,0	47,00	10,0/12,7	A
01132	GR	111,3	142,85	4,8	I
01135	BR	70,0	90,00	10,0	
01135	BRGS	70,0	90,00	10,0	
01135	BRP	70,0	90,00	10,0	
01140	BR	47,0	62,10	8,0	
01141	BR	45,0	66,20	6,0	
01147	BRG	48,0	65,10	7,0	
01148	BR	79,4	114,30	12,7	
01149	BA	31,8	44,50	6,5	
01149	BR	31,7	44,50	6,5	
01151	BRG	26,0	42,00	10,0	
01152	GR	35,0	46,50	4,8	
01154	B	31,7	44,50	9,5	
01155	B	40,0	55,00	9,0	
01156	GR	25,4	44,60	5,0	
01157	BR	34,0	62,10	10,0	
01160	BR	65,0	80,00	8,0	
01170	BAE	20,0	40,00	0,9/6,5	K
01175	BA	15,9	25,35	6,4	
01180	BR	55,0	85,00	13,0	
01181	BR	55,0	70,00	8,0	
01182	BR	30,0	72,00	9,5	
01183	BR	75,0	105,00	13,0	
01185	BAX	82,5	114,30	14,3	G
01187	BR	52,4	68,00	10,5	
01188	BR	28,4	45,00	8,5	
01189	BR	20,0	38,10	10,0	
01193	BR	130,0	160,00	12,0	
01194	BR	60,0	85,10	12,7	
01195	B	82,6	107,90	14,3	
01199	GB	49,0	76,00	17,4	A
01207	BAG	45,0	67,90	12,0	
01214	BR	24,0	37,00	7,0	
01219	BRGE	38,0	52,00	3,6/9,0	K
01235	BR	19,0	42,10	7,0	
01241	BAG	49,0	65,00	10,0	
01245	BR	20,0	40,00	6,0	
01247	BA	55,0	76,00	12,0	

Número Sabó	Tipo	Diâmetro do Eixo	Diâmetro do Alojamento	Altura do Retentor	Grupo
01251	BGO	92,1	123,85	21,0	
01252	BGO	101,6	139,75	14,3	
01253	B	89,0	114,25	12,7	
01254	BAG	20,7	34,85	11,9	
01257	B	95,3	120,55	12,7	
01262	BAG	49,0	68,00	12,0	
01265	BAG	40,0	56,00	9,0	
01266	BAG	40,0	65,00	12,0	
01268	BA	105,0	142,90	12,7	
01273	BA	30,0	62,00	10,1	
01276	GRE	39,5	54,50	3,0/16,0	K
01278	BA	54,0	65,00	8,0	
01284	B	38,1	50,30	11,1	
01289	GRE	45,0	58,25	5,0/18,0	K
01295	GR	25,0	40,00	5,0	
01299	BR	28,6	38,06	6,0	
01301	BA	79,0	111,55	10,7	
01302	B	25,4	47,55	11,1	
01306	GR	44,5	63,40	4,8	
01310	BAG	32,0	42,00	7,0	
01318	B	38,0	69,95	12,7	
01322	BR	40,0	62,10	10,0	
01323	GAE	35,0	45,60	2,5/5,6	I
01327	BAG	25,4	38,00	9,5	
01328	BA	20,0	31,20	7,5	
01340	BR	50,0	68,00	10,0	
01341	BR	24,0	40,10	10,0	
01343	BAG	34,9	63,00	13,0	
01344	BR	45,0	64,95	12,0	
01345	BA	60,3	85,05	6,4	
01348	BR	15,0	30,00	10,0	
01353	BRG	32,0	51,90	12,0	
01355	BR	38,1	50,10	7,0	
01356	BAG	25,4	38,10	6,3	
01356	BAG	25,4	38,10	6,3/8,8	A
01362	B	133,4	165,10	15,9	
01366	B	35,0	72,00	10,0	
01369	BA	47,6	70,55	13,5	
01370	BA	31,9	44,00	9,0	
01371	BAG	35,0	54,85	11,0	
01375	BR	100,0	120,00	11,0	
01377	B	31,7	52,30	9,5	
01378	B	41,3	61,80	12,7	
01386	BRG	20,0	35,00	8,0	
01389	BAG	14,0	24,00	7,0	
01392	BAG	60,0	80,00	12,0	
01393	BA	25,4	50,70	10,2	
01395	B	34,9	52,30	9,5	
01396	BA	38,1	55,55	6,4	
01397	BA	25,0	44,95	7,0	
01400	BR	18,0	47,00	8,0	
01401	BB	24,6	46,40	14,7	A
01402	F	17,5	-	3,2	Q

Número Sabó	Tipo	Diâmetro do Eixo	Diâmetro do Alojamento	Altura do Retentor	Grupo
01404	BR	20,0	35,10	4,0	
01405	GA	25,4	34,80	5,0	
01407	BR	19,0	36,05	8,5	
01408	BA	63,0	81,00	10,0	
01412	B	114,3	152,40	12,7	
01415	BRG	17,0	35,00	10,0	
01416	BAG	90,0	110,05	13,0	
01419	GA	40,0	50,00	4,0	
01420	BR	12,0	28,10	7,0	
01421	BR	36,0	54,00	7,5	
01422	BR	50,0	65,00	8,0	
01423	BR	8,0	18,00	5,0	
01424	BR	150,0	180,00	15,0	
01425	BA	62,0	100,05	17,0	
01427	BR	110,0	180,00	15,0	
01432	GA	38,0	52,25	6,2	
01445	BA	12,0	32,00	7,0	
01454	BGO	65,0	88,30	12,7	
01455	BA	19,0	28,65	4,7	
01456	BRE	24,0	62,00	3,0/12,0	K
01460	B	47,6	82,80	11,0	
01462	B	63,5	110,00	13,0	
01464	BA	17,0	31,20	7,5	
01465	BA	19,0	41,30	11,0	
01466	MFBE	114,0	174,40	16,0	R
01468	B	108,0	136,50	12,7	
01479	BR	11,1	25,40	6,0	
01481	BA	22,0	41,25	8,0	
01489	BGO	65,0	92,00	17,8	
01491	BA	40,2	52,00	7,0	
01492	BR	17,0	40,00	8,5	
01493	BR	15,9	28,50	7,0	
01495	BR	28,0	40,00	7,0	
01495	BRF	28,0	40,00	7,0	
01495	BRS	28,0	40,00	7,0	
01496	BR	17,5	28,30	7,0	
01502	BA	35,0	44,50	7,0	
01505	BR	42,0	65,05	10,0	
01506	BF	42,0	65,00	12,0	
01507	BR	24,0	42,00	10,0	
01508	B	12,7	25,30	9,5	
01509	BR	34,0	52,00	7,5	
01511	BR	17,0	35,00	8,0	
01515	BR	25,0	36,00	7,0	
01519	BR	47,6	79,25	10,0	
01526	BRG	35,0	46,45	6,4	
01527	BA	19,0	30,10	7,5	
01532	BR	44,5	65,05	8,0	
01534	F	42,0	-	10,0	Q
01535	BR	30,0	40,00	7,0	
01536	BA	38,1	47,60	6,4	
01539	GA	28,6	34,90	3,2	
01541	BAG	63,5	85,55	12,7	

Número Sabó	Tipo	Diâmetro do Eixo	Diâmetro do Alojamento	Altura do Retentor	Grupo
01543	BA	25,0	35,00	7,0	
01543	BR	25,0	35,00	7,0	
01546	GRX	46,0	65,57	11,1	G
01547	BGO	25,4	50,75	15,8	
01549	BR	100,0	125,00	12,0	
01550	BR	55,0	72,00	10,0	
01550	BRP	55,0	72,00	10,0	
01551	BR	35,0	58,00	10,0	
01552	BR	44,0	60,00	10,0	
01553	BR	45,0	72,00	9,5	
01554	BRG	22,0	32,00	7,0	
01556	BR	25,0	40,00	8,0	
01557	BR	55,0	70,10	11,5	
01559	BR	12,7	22,20	8,0	
01563	BA	32,0	47,50	6,4	
01566	BAO	20,0	30,00	4,0/7,0	A
01571	BBR	82,6	107,85	16,0	A
01575	GGO	44,5	57,07	10,9	A
01576	BAG	16,0	22,10	6,4	
01577	BR	25,0	37,10	7,3	
01580	B	28,0	42,00	7,0	
01581	BGO	30,0	72,00	10,0	
01587	BR	8,0	22,00	8,0	
01589	BR	33,0	52,00	6,0	
01595	BAGE	50,8	116,02	16,2	O
01602	BAG	40,0	72,00	12,0	
01603	BRG	33,0	50,00	6,0	
01604	BR	25,0	42,00	6,0	
01608	BR	37,0	50,00	10,0	
01613	GA	23,3	59,95	6,4	
01614	BRGO	9,0	23,20	3,2	D
01625	BR	27,0	42,00	10,0	
01630	BAG	31,7	42,80	7,9	
01632	FE	104,8	-	3,2	Q
01633	ME	111,3	174,50	4,0	R
01635	BR	28,6	57,15	9,5	
01637	GA	55,1	82,00	10,0	
01651	MFE	25,4	-	6,5/10,0	P
01656	BR	44,5	70,00	10,0	
01657	BA	38,0	57,00	7,0	
01659	BA	38,1	50,75	9,5	
01660	BAGE	39,4	80,20	6,4/11,8	A
01661	BAG	28,6	42,95	6,5	
01662	GAE	9,0	16,00	9,0/15,0	A
01666	BR	24,0	36,00	6,0	
01667	BR	30,0	42,05	8,0	
01669	BR	55,0	100,00	12,7	
01671	GA	50,8	65,10	12,7	
01672	BR	10,0	22,00	7,0	
01673	BA	75,0	95,00	5,0	
01676	BR	185,0	210,00	13,0	
01677	BR	15,0	30,00	7,0	
01678	GRX	39,7	68,15	13,0	G

Número Sabó	Tipo	Diâmetro do Eixo	Diâmetro do Alojamento	Altura do Retentor	Grupo
01679	BRG	44,5	68,20	15,9	
01679	BRGS	44,5	68,20	15,9	
01680	F	31,0	45,20	6,4	Q
01683	GA	26,3	33,30	3,2	
01684	BRGGG	40,0	62,00	12,0	A
01685	BR	6,4	19,10	6,4	
01687	BA	74,9	100,00	13,0	
01689	GB	66,7	101,60	17,4	A
01692	MFE	19,0	26,80	6,0	P
01694	BA	20,0	40,00	4,0	
01694	BAP	20,0	40,00	4,0	
01695	BR	30,0	47,00	6,0	
01698	B	31,7	50,30	11,1	
01699	BR	47,6	69,85	9,5	
01700	GR	15,9	30,30	4,5	
01703	GR	31,7	51,00	5,0	
01707	BRG	40,0	55,00	8,0	
01710	BAG	38,0	73,95	11,0	
01711	BRG	45,0	63,95	9,0	
01712	BAG	24,6	39,90	8,0	
01715	BR	32,0	43,00	7,0	
01716	BR	22,0	35,00	7,0	
01717	GA	14,0	23,90	6,0	
01718	BR	20,0	34,05	7,0	
01721	BR	100,0	130,00	12,0	
01721	BRGP	100,0	130,00	12,0	
01722	BAE	24,6	44,50	1,5/7,9	B
01723	BAE	19,9	44,40	1,6/7,9	B
01724	BAE	27,0	42,70	1,2/7,9	B
01725	BR	17,0	32,00	7,0	
01726	BR	32,0	45,00	6,0	
01727	BR	22,0	32,00	5,5	
01727	BR	22,0	32,00	5,5	
01735	BE	125,0	150,00	15,0	A
01735	BG	125,0	150,00	15,0	
01735	BG	125,0	150,00	15,0	A
01737	BR	11,0	17,00	4,0	
01738	B	45,0	60,00	10,0	
01739	B	110,3	133,30	12,0	
01740	B	50,0	65,00	10,0	
01741	GE	10,0	19,35	2,3/7,5	A
01742	BR	35,0	52,10	10,0	
01743	BS	30,0	52,00	9,0	
01744	B	32,0	52,00	9,0	
01745	BR	40,0	55,15	10,0	
01746	B	20,0	42,00	10,0	
01747	G	10,7	-	1,5/2,5	J
01751	BRG	27,0	40,00	7,0	
01755	BA	60,2	85,75	9,5	
01756	GAG	44,5	59,25	6,0	A
01759	GR	40,0	56,00	8,5	
01760	GR	45,0	62,00	8,0	
01762	BAGF	68,0	90,00	13,0	

Número Sabó	Tipo	Diâmetro do Eixo	Diâmetro do Alojamento	Altura do Retentor	Grupo
01764	BAGG	46,0	65,50	7,0/8,5	K
01764	BRG	46,0	65,50	7,0	
01765	BRE	25,6	42,00	7,0/10,3	A
01767	BR	85,0	110,00	12,0	
01769	BR	18,0	35,00	10,0	
01770	B	118,0	140,00	13,0	
01774	BRG	105,0	135,00	15,0	
01777	GA	20,0	35,00	4,5	
01778	GR	26,0	40,00	5,0	
01779	B	22,0	47,00	9,0	
01783	BRG	50,0	65,00	8,5	
01784	BRO	17,0	28,00	8,0	A
01785	GA	26,8	29,95	1,9	
01786	BRG	38,0	53,05	8,5	
01790	B	63,5	82,50	12,7	
01791	BF	87,3	114,30	22,2	A
01792	BRE	30,0	72,00	2,5/10,5	K
01793	BR	48,0	66,10	12,0	
01794	BAGE	52,0	114,00	13,0	O
01795	BAGE	58,0	120,00	12,8	O
01796	MA	52,4	61,20	11,5	E
01797	NOP	11,0	17,00	8,7/12,0	F
01798	BAG	58,0	85,00	13,0	
01799	BRX	17,0	40,00	11,0	G
01801	B	100,0	123,80	13,0	
01802	BR	42,0	62,00	6,0	
01803	BAG	38,1	50,35	11,0	
01803	BAG	38,1	50,35	10,9	A
01805	BE	100,0	128,00	15,0/25,0	B
01806	BRXE	143,3	150,00	39,5	G
01807	BAG	50,0	70,00	12,0	
01809	BS	42,0	65,00	13,0	
01810	BAGS	65,0	90,00	15,0	
01810	BRAGS	65,0	90,00	15,0	
01811	B	39,7	63,45	12,7	
01814	BRG	36,0	60,00	9,5	
01815	BAEP	9,0	15,00	10,0/14,0	F
01816	BA	15,0	24,00	7,4	
01817	BA	16,0	30,00	6,4	
01818	GAE	17,8	30,00	11,0	I
01819	BA	22,2	35,00	8,0	
01821	MFE	60,0	75,00	5,0	P
01822	BAP	130,0	160,00	13,0	
01825	BRG	54,0	76,00	8,0	
01826	BRXE	8,0	35,00	16,0	G
01828	B	61,9	79,95	10,0	
01829	B	90,0	112,70	13,0	
01830	GA	26,0	31,00	3,0	
01831	BA	30,0	46,40	10,0	
01832	BR	38,0	58,50	7,0	
01833	BA	29,9	45,00	7,0	
01834	BAGE	33,0	50,00	10,0/15,0	B
01835	BR	14,3	23,95	7,0	

Número Sabó	Tipo	Diâmetro do Eixo	Diâmetro do Alojamento	Altura do Retentor	Grupo
01836	B	23,8	38,05	7,9	
01837	BRGE	17,0	28,00	7,0/10,0	I
01838	BAG	54,0	79,40	12,7	
01839	BA	33,0	50,00	8,0	
01840	BGO	48,0	65,00	12,0	
01841	BRG	60,0	82,00	12,0	
01842	BRG	60,0	82,00	12,0	
01843	BA	31,7	44,45	7,0	
01844	BAG	34,9	55,90	12,5	
01845	BRP	44,5	63,50	9,5	
01846	BAG	15,0	30,00	7,0	
01847	GR	50,0	68,00	8,5	
01849	BAG	33,0	51,90	12,0	
01849	BAGE	33,0	51,90	3,0/12,0	K
01850	BRGE	38,0	52,00	2,5/8,5	K
01851	BRG	45,0	60,00	10,0	
01852	BRS	76,2	95,25	9,7	
01853	BR	9,5	19,05	7,0	
01854	BRG	38,1	60,35	12,7	
01855	BAG	50,0	87,00	12,7	
01856	BRGP	75,9	95,00	11,3	
01857	B	76,2	98,45	11,9	
01858	BAGE	44,4	53,95	8,6	A
01859	BAG	44,5	61,90	9,5	
01860	BA	26,0	45,00	10,0	
01861	BRG	50,0	72,00	12,0	
01862	BAG	57,3	76,20	9,5	
01863	BA	63,5	88,90	12,7	
01864	BAG	54,0	76,20	12,7	
01865	BGO	69,8	95,25	16,0	
01866	GR	20,0	35,10	5,8	
01867	GR	23,8	39,00	6,2	
01868	GA	19,0	28,50	4,0	
01869	GA	39,7	57,10	6,4	
01870	GA	63,5	76,20	6,4	
01871	GR	17,5	30,30	4,5	
01872	GA	57,2	76,00	9,5	
01873	GRE	30,5	38,00	7,9	I
01874	BRXE	74,5	80,10	22,0	G
01875	BR	14,0	32,00	10,0	
01876	GRXE	20,9	30,06	12,0	G
01877	BAG	38,2	60,35	12,7	
01878	B	50,8	71,90	11,9	
01879	BRG	70,0	95,00	13,0	
01880	BAG	69,8	98,45	11,8	
01880	BAGE	69,8	98,45	11,8/17,7	B
01881	GOE	49,2	63,50	1,5/7,4	K
01882	GA	36,6	41,75	3,0	
01883	BAG	21,0	32,00	7,0	
01884	BG	120,0	144,95	15,0	
01885	BAGP	120,0	140,15	13,0	
01886	GR	28,0	38,00	6,5	
01889	GAO	15,0	34,95	10,0/12,7	A

Número Sabó	Tipo	Diâmetro do Eixo	Diâmetro do Alojamento	Altura do Retentor	Grupo
01890	GAO	25,0	52,00	10,0/12,7	A
01891	NEO	47,0	56,75	14,0	N
01892	BRG	25,0	37,90	7,0	
01893	GE	35,0	46,00	21,0	E
01894	BRG	19,9	35,00	7,0	
01895	BRG	29,9	52,00	8,0	
01896	BRE	35,0	50,00	7,0/12,4	I
01897	BRGEP	39,4	69,85	6,4/16,2	B
01898	BRGEP	39,4	80,25	6,4/16,2	B
01899	BRGE	42,9	65,00	9,5/15,0	B
01900	GAE	85,7	107,95	7,9/14,6	B
01901	BGO	101,8	127,10	11,9	
01902	BR	48,0	72,00	10,0	
01903	BRP	30,0	40,00	7,0	
01904	BRP	10,0	22,00	7,0	
01905	BR	35,0	58,00	10,0	
01906	BA	45,0	72,00	10,0	
01907	BR	15,0	32,00	7,0	
01909	BR	19,0	29,10	6,4	
01910	BRP	150,0	180,00	13,0	
01910	BRS	150,0	180,00	13,0	
01911	BRG	45,0	60,00	9,0	
01911	BRGF	45,0	60,00	9,0	
01912	BRG	85,7	114,20	11,2	
01913	MF	44,5	66,60	12,7	P
01914	BRP	22,0	42,00	10,0	
01915	BAGP	15,0	30,00	6,0	
01916	BAGP	17,0	34,00	7,0	
01917	BRGS	78,0	100,00	13,0	
01918	BRGE	44,0	65,00	2,5/12,2	K
01919	BRGO	20,0	34,80	3,0	D
01923	BG	82,5	114,30	12,7	
01923	BGG	82,5	114,30	12,7	A
01923	BY	82,5	114,30	12,7	M
01924	BAEP	9,9	15,00	10,0/14,0	F
01925	GRE	138,0	184,00	12,0/38,0	I
01927	BRP	70,0	90,50	10,0	
01928	B	146,0	168,25	16,0	
01929	BRG	15,0	24,00	7,0	
01930	BAG	54,1	73,00	8,5	
01931	BAG	41,4	70,60	7,9	
01932	GRE	59,0	79,70	9,7/11,8	B
01933	BABEP	54,0	81,10	20,7	I
01934	BAG	15,9	30,00	6,0	
01935	BAG	20,0	30,00	7,0	
01941	GAE	109,7	140,00	12,0/40,0	I
01942	BRGP	32,0	47,00	10,0	
01943	BAGEP	43,4	56,00	1,6/9,0	K
01945	BRGS	82,0	105,00	12,0	
01949	BR	35,0	62,00	10,0	
01950	BAG	52,0	72,00	12,0	
01951	BR	160,0	200,00	12,0	
01952	BA	30,0	52,00	12,0	

Número Sabó	Tipo	Diâmetro do Eixo	Diâmetro do Alojamento	Altura do Retentor	Grupo
01953	BRG	133,0	160,00	15,0	
01953	BRGP	133,0	160,00	15,0	
01954	BR	35,0	80,00	12,0	
01955	BAGS	47,6	63,50	11,0	
01957	BA	12,7	28,55	6,5	
01958	BAGS	40,5	53,95	7,2	
01959	BAG	15,0	35,00	7,0	
01962	BA	28,6	41,30	9,4	
01963	BAG	41,1	49,30	6,5	
01964	BA	28,6	38,10	6,5	
01965	BAP	19,0	34,95	10,3	
01966	BA	12,7	25,35	6,4	
01967	BAS	21,8	36,50	6,4	
01968	BRS	100,0	125,00	12,0	
01969	BRGS	55,0	72,00	10,0	
01971	BAGE	12,4	39,40	4,5	D
01972	BRGS	133,3	158,75	13,0	
01973	GA	50,0	58,00	4,0	
01974	BRG	100,0	130,00	13,0	
01975	U	31,0	47,00	12,0	C
01976	B	165,1	193,65	15,7	
01977	GR	14,3	22,00	3,9	
01978	GROX	14,7	22,10	7,0	G
01980	BR	35,0	55,00	8,0	
01981	BRGS	85,0	105,00	12,0	
01984	GA	7,8	14,10	3,6	
01985	BR	21,0	31,95	7,0	
01987	BRGO	20,0	32,00	3,0	D
01988	BAGE	40,0	52,00	7,0	A
01988	BAGE	40,1	52,00	7,9	A
01988	BRG	40,0	52,00	7,4	
01988	BRG	40,1	52,00	7,4	
01988	BRGE	40,1	52,00	1,9/7,7	K
01989	BAG	41,3	59,10	8,0	
01990	G	14,9	-	2,1/2,9	J
01991	G	27,0	-	2,5/3,3	J
01992	BR	30,3	39,65	6,4	
01993	BR	27,0	38,10	6,4	
01994	BR	49,2	79,35	12,5	
01995	BR	58,7	79,35	9,6	
01996	BRO	42,9	73,00	15,9	A
01997	BRO	39,4	60,30	12,7	A
01998	BR	28,6	39,75	6,4	
02001	GA	10,3	16,00	4,0	
02002	U	22,0	32,00	8,0	C
02004	BAGP	64,0	80,00	8,0	
02005	BAGP	40,0	56,00	7,0	
02006	BAG	30,0	52,00	7,0	
02007	BAGP	25,0	35,00	7,5	
02008	BAGE	16,0	26,00	9,0/20,0	D
02009	BP	22,0	40,00	8,0	
02010	BAG	25,0	47,00	7,0	
02010	BRO	25,0	47,00	7,0	

Número Sabó	Tipo	Diâmetro do Eixo	Diâmetro do Alojamento	Altura do Retentor	Grupo
02011	NEF	33,0	44,50	5,3	N
02012	BRF	33,0	45,00	7,0	
02013	BAP	8,0	16,00	7,0	
02014	BAGP	44,0	60,00	10,0	
02017	GB	73,5	95,00	18,0	A
02018	BAGE	88,9	152,40	39,1	I
02019	BAGE	82,6	134,55	41,2	I
02020	S	14,2	50,70	10,7/46,1	U
02021	B	108,2	144,45	19,0	
02022	GRGGO	20,0	35,00	7,0/11,0	D
02023	GRGGO	30,0	42,00	8,0/9,0	D
02024	BRGG	47,0	58,00	7,0	A
02025	BA	14,0	20,00	3,5	
02026	GGGX	52,4	74,70	8,4	G
02027	BGO	41,1	62,05	16,0	
02029	BR	23,8	34,50	7,0	
02031	BR	40,0	56,00	7,0	
02032	BA	25,4	34,95	6,4	
02033	BAE	63,6	155,60	12,0	O
02034	BRG	38,1	63,55	12,7	
02035	GB	79,0	110,00	17,4	A
02036	GB	73,0	101,60	18,3	A
02037	GB	92,2	123,85	19,0	A
02038	BRG	39,4	63,55	12,7	
02039	BR	42,0	72,00	10,0	
02044	BAGE	150,8	229,40	28,6	O
02046	BRG	25,0	47,00	10,0	
02049	BG	100,0	119,95	13,0	
02051	BR	38,0	54,00	10,0	
02052	BAGP	31,7	53,95	6,5	
02053	BAGP	41,3	63,55	6,5	
02054	BR	161,9	187,30	9,5	
02055	BR	47,7	65,00	8,0	
02056	BR	165,0	190,50	12,7	
02058	BAGF	42,0	55,00	9,0	
02059	BA	42,0	58,00	7,0	
02060	GB	97,8	116,00	16,0	A
02061	BRGF	70,0	90,00	15,0	
02062	BA	25,0	40,00	7,0	
02063	BAG	31,7	50,80	11,1	
02064	BAG	22,2	50,80	11,1	
02065	BAE	190,5	285,80	48,7	O
02066	BAG	57,2	73,00	8,0	
02067	BAG	57,1	76,10	11,0	
02068	BRGP	40,0	52,00	9,0	
02069	BRGS	130,0	160,00	15,0	
02070	BBO	20,0	38,05	18,3	A
02071	BRGE	38,5	45,58	8,0/14,7	K
02072	BAP	20,0	38,05	6,4	
02073	GA	21,8	25,00	1,9	
02075	BREP	20,0	35,00	7,0/10,6	A
02077	BAG	60,3	79,35	9,5	
02084	BAGP	41,2	63,50	8,0	

Número Sabó	Tipo	Diâmetro do Eixo	Diâmetro do Alojamento	Altura do Retentor	Grupo
02084	BAP	41,2	63,50	8,0	
02085	BA	69,9	88,90	12,7	
02087	BAG	35,0	56,00	10,0	
02088	BGO	40,0	65,00	12,0	
02089	BGOE	139,7	160,25	31,7	A
02090	BABE	60,3	85,75	22,8	I
02091	BAG	35,0	62,00	12,0	
02092	BGO	117,5	146,00	14,3	
02093	BRG	150,8	177,80	12,5	
02094	BAGE	28,0	40,00	10,5	D
02095	GA	35,0	42,00	4,0	
02096	BA	30,0	37,10	4,0	
02097	BREP	8,0	14,10	7,1/10,4	F
02098	BAE	60,3	149,40	8,3	O
02099	BA	36,0	54,00	7,0	
02100	BAG	58,0	75,00	12,0	
02102	BA	34,9	50,85	8,3	
02103	BAG	57,2	82,50	9,5	
02103	BAGE	57,2	82,50	9,5/11,5	B
02104	BA	44,5	63,55	8,0	
02106	GA	28,0	40,00	5,0	
02107	GA	25,0	35,00	5,0	
02108	BRG	50,0	68,00	9,0	
02110	BRG	45,0	62,00	9,0	
02111	BRG	55,0	72,00	9,0	
02112	BRG	58,0	75,00	9,0	
02113	BR	65,0	100,00	13,0	
02115	BRGS	122,2	140,80	11,8	
02116	BAP	60,3	82,50	11,0	
02117	BAS	101,6	126,90	11,2	
02118	BREP	8,0	14,10	7,1/10,4	F
02125	BGP	95,3	114,25	12,0	
02126	GA	22,1	35,00	8,0	
02127	BGP	76,2	101,65	11,0	
02128	BA	38,0	62,00	7,0	
02130	BAG	15,0	21,00	4,0	
02131	BAG	19,0	28,55	6,5	
02132	BRES	22,3	35,74	3,7/10,0	K
02134	BGE	117,4	157,10	13,5/26,5	B
02135	GA	10,0	14,00	3,0	
02138	B	174,6	200,00	16,0	
02139	BRG	48,0	72,00	7,0	
02140	BAP	28,7	40,00	7,0	
02142	BRGF	32,0	47,00	10,0	
02143	BRGGG	21,0	37,00	7,0/10,0	A
02144	GR	32,0	43,00	5,0	
02145	BRG	28,0	42,00	7,0	
02148	BRG	25,0	40,00	9,0	
02151	BA	35,0	80,00	6,0	
02152	BAGGG	34,0	55,00	11,0/15,0	A
02153	BRG	29,4	42,83	8,0	
02155	BRGE	39,4	80,10	6,4/16,2	B
02156	BAGF	125,0	150,00	15,0	

Número Sabó	Tipo	Diâmetro do Eixo	Diâmetro do Alojamento	Altura do Retentor	Grupo
02157	BRO	28,0	39,95	8,0	A
02160	BR	10,0	22,00	7,0	
02161	BR	17,0	25,00	4,0	
02162	BRG	14,0	24,00	6,0	
02163	BRG	8,0	18,00	5,0	
02164	BRG	18,0	37,00	8,0	
02165	GRGG	26,0	42,00	8,0/9,0	D
02166	BRG	6,8	22,00	7,0	D
02167	GAE	29,5	37,00	7,5	I
02169	BA	45,0	62,00	7,0	
02170	GR	10,0	24,35	5,5	D
02171	BR	10,0	19,00	6,5	
02172	BG	25,4	38,05	8,0	
02175	BRGP	45,0	60,00	8,0	
02176	BRG	16,0	24,00	6,0	
02178	BRAGS	35,0	48,00	7,0	A
02178	BRGS	35,0	48,00	7,0	
02180	BG	114,3	155,55	14,0	
02181	BAG	55,5	80,90	15,5	
02184	BAGP	32,0	65,00	13,0	
02185	BAGF	140,0	165,00	15,0	
02191	BRF	75,0	95,00	12,0	
02192	BRGP	70,0	90,00	10,0	
02193	BRG	57,1	76,20	12,7	
02194	GB	101,6	127,00	16,0	A
02195	BR	105,0	140,00	12,0	
02196	BR	44,3	81,00	12,5	
02197	BRG	54,0	73,00	9,5	
02198	GR	7,8	13,80	3,6	
02199	BAGF	75,0	100,00	17,0	
02201	BRGEP	47,6	80,25	6,5/16,5	B
02203	BAG	18,8	31,70	11,0	
02204	BAGP	60,3	90,00	12,5	
02205	BAGP	54,0	90,00	12,5	
02206	BAGP	60,3	79,40	12,0	
02207	BAGP	54,0	73,00	11,0	
02208	BAGP	90,0	120,00	12,0	
02209	BAGE	47,6	80,00	13,0/26,0	B
02210	BRG	24,0	37,00	7,0	
02211	BAG	63,5	83,80	9,0/11,5	B
02212	BRGE	40,0	52,00	2,8/8,5	K
02213	B	98,4	126,90	12,0	
02214	B	114,3	139,65	12,7	
02215	BG	31,8	44,45	8,0	
02216	GAG	17,8	32,15	5,5	A
02219	BAGF	155,0	180,00	16,0/29,0	B
02221	BA	34,9	50,75	8,3	
02223	B	140,0	180,00	15,0	
02224	BR	35,0	56,00	10,0	
02225	BR	40,0	68,00	12,0	
02226	BG	75,0	100,00	13,0	
02230	B	25,4	38,00	6,5	
02231	GAO	25,0	62,00	10,0/13,0	A

Número Sabó	Tipo	Diâmetro do Eixo	Diâmetro do Alojamento	Altura do Retentor	Grupo
02232	GAO	20,0	52,00	10,0/13,0	A
02233	BRG	25,0	40,00	8,0	
02234	BRG	30,0	42,00	10,0	
02235	BAGS	80,0	100,00	12,0	
02236	BAP	57,0	85,00	12,0	
02239	GAE	11,0	16,60	6,0/8,5	A
02241	GRG	25,0	47,00	8,0	A
02242	BG	33,3	53,95	11,0	
02244	B	29,0	50,00	10,0	
02245	BAG	133,4	155,55	14,0	
02246	BAG	168,0	188,00	31,5	
02248	GA	9,4	21,40	5,0	
02249	GA	12,6	21,40	5,0	
02255	GA	63,9	73,00	3,2	
02256	BAG	63,6	88,90	13,5	
02257	GAE	31,7	44,45	1,5/5,9	K
02258	GAE	22,0	32,00	1,9/5,0	K
02259	GAG	26,0	34,00	5,0	A
02261	GAE	25,0	35,00	5,0/7,0	A
02262	BAG	50,8	65,05	12,7	
02263	BR	19,0	31,60	7,7	
02264	BRGF	85,9	104,00	11,0	
02265	GA	25,0	32,00	4,0	
02267	BBO	60,3	85,75	23,8	A
02269	BAGP	70,0	85,00	8,0	
02270	B	32,0	72,00	10,0	
02271	BGP	66,7	92,00	11,0	
02272	BGP	66,7	85,60	12,0	
02274	BRX	48,0	80,00	13,0	G
02279	BAG	15,0	26,00	6,0	
02283	BRGF	85,0	105,00	12,0	
02285	BA	20,0	31,00	7,0	
02286	BRGO	20,0	34,80	3,0	D
02287	BGP	54,0	79,35	9,5	
02289	BAG	38,0	74,00	11,0	
02290	BRGO	22,0	32,88	3,0	D
02291	BAF	80,0	100,00	12,0	
02292	BAF	68,0	90,00	10,0	
02293	BF	145,0	175,00	13,0	
02295	BA	44,0	58,00	7,0	
02296	BRG	42,0	60,00	9,0	
02297	BAGF	70,0	85,00	8,0	
02298	BAG	45,0	62,00	9,0	
02299	BAGE	93,0	157,00	7,4	O
02300	BREP	8,0	14,10	8,9/13,0	F
02302	BAGF	40,0	56,00	7,0	
02303	BRG	35,0	63,10	14,0	
02304	BRG	35,0	60,30	9,5	
02305	BAG	46,3	66,60	0,8/6,7	K
02306	BRG	6,5	14,50	7,0	
02307	NEP	5,5	9,20	7,0/8,0	F
02308	BRG	14,0	28,00	7,0	
02309	BRP	15,0	25,00	7,0	

Número Sabó	Tipo	Diâmetro do Eixo	Diâmetro do Alojamento	Altura do Retentor	Grupo
02310	BRG	16,0	28,00	7,0	
02311	BR	20,0	34,00	7,0	
02312	BRGE	27,0	39,00	10,5	D
02312	BRGE	27,0	39,00	10,5	D
02315	GA	34,9	53,50	6,5	
02316	GA	57,2	82,55	6,5	
02317	BRAGF	31,0	50,00	8,0	A
02317	BRGF	31,0	50,00	8,0	
02318	BRGE	30,0	40,50	10,5	D
02319	BRGE	15,0	21,00	2,0/14,0	K
02321	BAG	42,0	56,00	7,0	
02322	GA	40,8	44,05	3,1	
02324	BRG	45,0	65,00	8,0	
02325	BRGP	90,0	115,00	13,0	
02326	BRGP	58,0	80,00	12,0	
02327	BREP	8,0	13,00	7,5/9,3	F
02328	GE	35,0	46,00	26,0	E
02329	BRG	18,0	30,00	7,0	
02333	BAE	60,3	155,50	7,4	O
02334	BAG	14,3	39,55	6,3	
02335	BAG	15,9	22,20	4,3	
02336	BROE	35,0	45,15	15,0/24,0	I
02337	GA	28,6	40,20	5,0	
02342	GA	51,0	58,00	4,0	
02343	BAP	12,7	22,20	8,0	
02345	BRAGF	77,0	100,10	11,5	A
02347	GRE	105,0	135,00	12,0	A
02351	BAGE	80,0	112,00	12,0/18,0	B
02352	B	85,7	107,85	12,7	
02353	BRGE	35,0	48,00	10,5	D
02354	GAE	12,5	28,60	9,0	I
02355	BA	28,6	41,25	6,5	
02356	BA	41,3	54,00	6,5	
02357	BA	22,2	31,70	6,0	
02358	BA	7,0	16,00	7,0	
02360	BRF	12,5	20,00	5,0	
02361	GA	28,7	31,78	3,1	
02365	BAG	47,8	65,00	11,7	
02366	BAGE	69,8	98,45	11,8/17,8	B
02368	GAE	45,0	61,90	5,5/10,0	I
02370	BRAGE	35,0	54,00	10,0/15,0	B
02371	BAG	21,0	32,00	7,5	
02371	BAG	21,0	32,00	7,5	
02372	BAG	23,0	35,00	8,0	
02373	BRG	13,0	26,00	7,0	
02374	BAGE	35,0	54,90	0,7/14,7	K
02375	BR	17,0	28,05	5,0	
02376	BRG	30,0	47,00	7,0	
02377	BG	40,0	62,00	12,0	
02378	BR	44,3	60,00	7,0	
02380	BRXE	8,0	35,00	13,0	G
02381	BA	57,2	82,45	9,5	
02382	BREP	7,0	10,90	6,4/11,0	F

Número Sabó	Tipo	Diâmetro do Eixo	Diâmetro do Alojamento	Altura do Retentor	Grupo
02385	BA	38,1	47,60	7,0	
02386	BG	108,0	133,35	12,0	
02388	GRG	30,0	72,25	3,0/20,0	K
02391	BRG	40,0	55,00	8,0	
02392	BRGE	55,0	70,00	6,0/10,3	B
02393	BAGE	54,0	79,35	12,7/19,0	B
02395	BAGG	45,0	73,12	13,0	A
02396	BREF	8,0	12,00	7,0/11,0	F
02397	BRG	32,0	45,00	7,0	
02398	BAGS	70,0	85,00	8,0	
02399	BRGS	64,0	90,00	10,0	
02400	BREF	8,0	14,10	8,9/13,0	F
02401	B	30,0	52,00	9,0	
02407	BA	29,9	58,10	8,0	
02408	BRGO	20,0	32,18	3,0	D
02409	GR	8,0	-	2,5	D
02410	GRG	40,0	90,15	3,0/20,0	K
02411	GRG	25,0	52,00	2,0/15,0	K
02412	BRG	26,0	40,00	8,0	
02413	BRG	28,0	40,00	8,0	
02414	BRG	25,0	35,00	8,0	
02415	BAG	55,4	76,15	12,7	
02416	BAG	82,5	120,00	15,0	
02417	BAGE	60,3	92,00	12,0/18,5	B
02418	BR	21,5	40,00	7,0	
02419	BAG	40,0	55,00	9,5	
02420	BAGE	15,0	28,00	6,0/15,0	D
02422	BRP	69,8	90,00	8,0	
02423	BAG	69,8	90,00	10,0	
02424	BG	89,0	114,25	12,7	
02425	BR	17,0	32,00	7,0	
02426	BRG	58,0	75,00	9,0	
02430	BRGF	40,0	52,00	8,0	
02432	GR	17,0	39,70	3,3	D
02433	BRG	20,0	39,70	6,5	
02434	BRE	25,0	35,00	3,8/7,5	B
02435	GRG	50,0	110,15	3,0/23,0	K
02438	BRG	39,4	63,55	12,5	
02441	GRG	15,0	22,00	4,0	A
02442	BAGE	50,0	65,00	9,7/14,0	B
02444	GA	38,0	43,00	3,0	
02445	BR	68,0	90,00	10,0	
02448	BRAGF	60,3	82,50	11,0	A
02449	BRGF	122,2	140,80	12,0	
02450	BRGP	90,1	110,00	13,0	
02451	BRG	75,0	90,00	10,0	
02454	BRG	15,0	25,00	7,0	
02456	BRGS	35,0	50,00	8,0	
02461	BRGE	28,5	39,75	8,0	D
02463	BAGE	14,2	48,20	4,7	D
02464	BRO	94,7	120,00	12,0	A
02465	BAG	23,8	38,05	6,5	
02467	BAGAP	23,0	37,00	13,5	A

Número Sabó	Tipo	Diâmetro do Eixo	Diâmetro do Alojamento	Altura do Retentor	Grupo
02468	BRG	20,0	40,00	7,0	
02469	GRG	40,0	50,00	5,0	A
02474	BRG	11,1	22,20	6,5	
02478	BAGF	63,5	82,55	12,7	
02480	BAGP	20,6	38,10	7,0	
02481	BRAGF	35,0	65,00	8,0	A
02482	GRG	34,5	46,50	6,5	A
02483	BGE	88,9	115,40	16,2/19,2	B
02484	BGE	88,9	122,95	18,7/21,7	B
02485	BY	98,4	144,54	16,0	M
02486	BR	20,0	34,95	7,0	
02490	BY	142,8	182,50	24,0	M
02491	GR	8,0	15,00	3,0	
02492	GR	16,0	22,00	3,0	
02494	BRAGF	42,0	72,00	10,0	A
02495	BRF	8,0	14,00	3,0	
02496	BY	127,0	158,75	16,0	M
02497	BRGF	54,0	77,70	11,0	
02498	BRGF	63,5	88,90	11,0	
02499	BRGF	69,8	92,00	11,0	
02503	BREP	9,0	11,50	6,0/10,1	F
02504	BAGP	63,5	82,55	12,7	
02505	BA	38,0	47,60	6,5	
02506	BR	38,0	52,25	7,0	
02509	BREF	7,0	11,00	7,0/10,0	F
02510	GA	18,0	24,00	3,0	
02511	BRAGF	66,7	88,80	11,0/12,5	A
02512	BRGE	57,2	82,60	0,9/14,0	L
02513	BREF	9,4	15,90	7,0/12,5	F
02515	GR	6,0	10,00	2,5	
02516	BRGEP	47,6	68,00	14,0	K
02516	BRGEP	47,8	68,00	0,9/14,0	L
02517	GRGX	55,0	70,00	12,0	G
02518	GRGX	50,0	65,10	12,0	G
02519	BRG	28,0	40,00	8,0	
02520	GAE	28,0	40,60	1,0/5,0	K
02521	GA	40,8	44,05	3,2	
02522	GA	45,6	48,75	3,2	
02523	BRF	11,0	17,00	4,0	
02524	BRAGF	80,0	98,00	10,0	
02525	BRAGF	26,0	42,00	8,0	
02526	GAG	20,0	28,00	4,0	A
02527	BAGP	25,4	44,50	6,5	
02528	GRL	35,6	50,75	7,8/9,6	I
02529	BRG	55,0	80,00	8,0	
02530	BRG	65,0	85,00	10,0	
02531	BR	75,0	95,00	10,0	
02532	BRGE	8,0	-	9,0	D
02533	BRGP	22,0	35,00	7,0	
02534	GAG	14,0	20,00	2,5	A
02535	BRG	12,0	22,00	5,0	
02536	BR	8,0	14,00	3,0	
02541	BRGP	40,0	55,00	8,0	

Número Sabó	Tipo	Diâmetro do Eixo	Diâmetro do Alojamento	Altura do Retentor	Grupo
02544	BREF	8,0	10,80/14,00	6,2/10,3	F
02545	BROF	125,0	150,00	31,7	A
02546	BRO	70,0	86,00	10,0	A
02547	BRO	50,0	80,00	12,0	A
02549	BRP	28,2	37,95	6,0	
02552	GRB	16,0	31,18	7,0	D
02553	NE	16,0	31,10	3,0	D
02556	BAF	68,0	85,00	10,0	
02557	BRG	68,0	85,00	10,0	
02558	BAF	47,6	57,15	5,0	
02560	BGF	69,9	92,25	12,7	
02561	BRGEP	60,3	92,00	2,5/14,0	L
02562	BRGEP	69,8	98,40	2,5/11,5	L
02565	BGF	38,0	50,35	11,0	
02566	BRGF	20,0	40,00	7,0	
02567	GR	18,0	24,00	4,0	
02568	BRG	26,0	35,00	7,0	
02569	BRGP	14,0	22,00	4,0	
02570	BRGF	25,0	40,00	7,0	
02571	BRG	17,0	25,00	4,0	
02572	BRG	22,0	35,00	7,0	
02573	GR	20,0	26,00	4,0	
02574	BR	90,0	110,00	12,0	
02575	BRAGF	34,9	52,00	7,0	
02576	GAG	14,2	28,55	13,5	A
02578	BRGF	60,4	79,40	9,3	
02579	BRG	22,0	35,00	7,0	
02580	BAG	44,4	63,50	12,7	
02581	GAE	47,0	63,00	5,6/11,2	K
02582	BRGO	20,0	33,80	32,0	D
02583	BRGF	133,3	158,75	13,0	
02588	GR	25,0	32,00	4,0	
02589	GR	15,0	21,00	3,0	
02590	NF	9,5	14,30	12,3/14,3	F
02591	BRG	46,0	56,00	4,0	
02592	GAG	20,0	26,00	4,0	A
02593	BR	30,0	47,00	6,0	
02594	BRF	24,0	35,00	6,0	
02595	BRF	31,0	62,10	4,0/5,5	A
02598	BRGO	20,0	34,80	3,6	D
02600	BRAGF	90,0	104,00	11,0	A
02604	BRGF	92,1	107,70	10,0	
02606	BAF	85,0	105,00	10,0	
02607	BRG	85,0	105,00	11,0	
02612	BRGF	122,2	140,80	11,8	
02613	BRGE	15,8	35,80	9,2	D
02615	GRE	8,0	19,50	2,3	D
02618	GRG	16,7	35,00	6,5/8,3	B
02619	BRAGF	112,5	130,00	11,0	A
02620	BRGO	20,0	31,70	3,3	D
02622	BRGO	22,0	35,20	3,8/10,2	D
02629	BRAGF	91,0	111,00	10,0	A
02632	GR	35,0	42,00	4,0	

Número Sabó	Tipo	Diâmetro do Eixo	Diâmetro do Alojamento	Altura do Retentor	Grupo
02633	GR	40,0	50,00	4,0	
02634	GR	45,0	55,00	4,0	
02635	GR	55,0	65,00	5,0	
02636	GR	60,0	72,00	6,0	
02637	GR	70,0	85,00	7,0	
02638	GR	12,0	18,00	3,0	
02639	GR	15,0	23,00	3,0	
02640	GR	17,0	25,00	3,0	
02641	GR	20,0	28,00	4,0	
02642	GR	25,0	32,00	4,0	
02643	GR	30,0	37,00	4,0	
02646	BRGO	8,0	23,20	2,9	D
02654	BR	28,6	39,70	9,5	
02656	BRAF	55,0	70,10	8,0	A
02657	BRAGS	26,0	42,00	8,0	A
02658	BRGF	43,0	75,00	10,0	
02660	BRGF	54,0	77,70	11,0	
02661	BRG	80,0	100,00	12,0	
02662	BRG	80,0	100,00	12,0	
02663	NF	9,9	14,30	13,1/14,5	F
02664	BAGP	80,0	100,00	10,0	
02666	GRE	30,0	40,75	4,2	D
02667	BRGP	57,2	77,75	10,0	
02669	GA	17,0	25,00	4,0	
02671	BRGF	75,0	100,00	10,0	
02672	BRG	30,0	72,00	6,5	A
02673	BRX	57,0	85,00	13,0	G
02674	NF	10,2	14,30	13,1/14,5	F
02675	BRG	40,0	82,90	10,0	
02677	BRG	70,0	85,00	8,0	
02678	BRGS	30,0	47,00	7,0	
02679	BRG	145,0	175,00	14,0	
02681	BRAGF	29,9	42,00	7,0	A
02682	BRAGF	42,0	55,00	10,0	A
02683	GAG	15,0	35,00	8,0	A
02685	BR	60,0	90,00	8,0	
02686	BRGEP	63,5	98,45	3,0/15,0	L
02687	BRGEP	76,3	125,35	3,0/19,5	L
02688	BAGGF	65,0	85,00	10,0/13,0	A
02689	BAG	12,0	20,00	5,0	
02690	BRG	95,0	115,00	13,0	
02691	GA	27,0	33,95	3,0	
02693	BRGE	54,0	80,00	11,1/16,6	B
02695	BRGGG	70,0	90,00	14,0	A
02696	BRAGF	105,0	130,00	12,0	A
02697	BRAG	120,0	140,00	13,0	
02698	GR	18,0	24,00	4,0	
02699	BRG	32,0	52,00	7,0	
02700	GRG	20,0	27,00	5,0	A
02701	BRG	17,0	28,00	5,0	
02702	BRAGF	80,0	98,00	10,0	A
02703	GAE	27,0	33,00	4,0	D
02704	GAE	30,7	36,70	7,0	I

Número Sabó	Tipo	Diâmetro do Eixo	Diâmetro do Alojamento	Altura do Retentor	Grupo
02705	GAE	26,7	32,70	4,0	I
02706	GAE	56,0	63,20	11,0	I
02707	GAE	37,0	45,00	12,0	I
02710	GRGE	20,0	37,00	8,0/11,0	D
02711	GRGE	35,0	48,20	5,0/14,4	K
02712	BRGP	25,0	40,00	8,0	
02713	BRY	121,1	160,20	35,0	M
02715	GA	22,2	28,58	3,2	
02716	BAEF	19,0	50,80	1,7/7,7	O
02720	BRGP	45,0	62,00	9,0	
02721	BRGP	48,0	66,00	11,0	
02722	BR	19,0	36,30	8,5	
02723	BAF	48,0	75,00	8,0	
02725	GRE	30,0	39,75	4,2	D
02726	BRGO	20,0	32,25	3,5	D
02727	BRG	25,0	52,00	8,0	
02728	BRGE	28,0	52,00	6,0/9,0	A
02729	BA	21,9	32,00	6,0	
02729	BA	21,9	32,00	6,0	
02730	BRG	17,0	30,00	7,0	
02731	BAGF	28,6	41,20	7,0	
02732	BRG	35,0	82,90	10,0	
02734	NE	8,6	17,00	13,0/15,2	F
02735	GB	63,0	110,00	13,0	A
02736	GA	45,0	51,90	4,0	
02737	GB	41,0	73,00	13,0	A
02740	BRGP	21,8	35,00	7,0	
02741	BRGGP	40,0	60,00	10,0/11,5	A
02743	BRGO	7,9	23,20	3,2/7,2	D
02744	GY	30,0	52,00	10,0	M
02745	BRG	45,0	60,00	7,0	
02751	BRG	90,0	120,00	12,0	
02753	BRG	75,0	95,00	13,0	
02759	BAG	72,5	92,20	9,0	
02762	BR	8,0	15,00	5,5	
02763	BAE	22,0	31,75	6,0	A
02770	BB	125,0	150,00	12,0	A
02771	BB	150,0	180,00	15,0	A
02777	BRAS	51,0	65,00	7,0	A
02778	B	145,0	175,00	13,0	
02780	BRF	76,0	89,70	5,5	
02784	BAGF	44,4	63,50	12,7	
02786	BREF	12,0	16,15	10,0/14,2	F
02788	GA	30,0	36,95	3,0	
02792	BAG	12,0	28,05	8,0	
02793	BRGF	42,0	58,00	7,0	
02794	BRAGF	38,0	50,00	8,0	A
02797	BRGEF	25,0	38,00	10,5/14,5	K
02801	BAF	85,0	105,00	10,0	
02802	BRGF	25,0	35,00	7,0	
02804	BAGE	88,9	152,40	30,4	I
02805	BAGE	82,6	134,55	41,2	I
02806	NES	8,6	13,50	13,0/15,2	F

Número Sabó	Tipo	Diâmetro do Eixo	Diâmetro do Alojamento	Altura do Retentor	Grupo
02812	GAE	20,0	27,00	2,0/4,0	D
02813	BRG	30,0	52,00	8,0	
02814	GRG	22,2	27,95	8,0	A
02815	GAE	29,0	35,00	6,0	I
02817	BRAGF	30,0	50,00	7,0	A
02818	BRAGF	50,0	65,00	9,0	A
02819	GAE	50,8	58,80	3,6/4,6	K
02821	BRG	20,0	35,00	6,0	
02822	BRG	40,0	52,00	6,0	
02828	BR	28,5	38,00	6,0	
02830	BRG	18,2	30,00	6,0	
02831	BAGP	30,0	52,20	7,0	
02833	BAGG	48,0	65,50	7,0	
02836	BAGEF	35,0	54,90	9,0/14,7	K
02837	BRAGF	23,0	35,00	8,0	
02842	BRGF	32,0	47,00	10,0	
02843	BRGF	32,0	47,00	10,0	
02844	BRAGF	40,0	56,00	7,0	A
02845	BRAGF	70,0	85,00	8,0	A
02847	GA	55,0	62,90	5,0	
02850	GRE	14,8	24,80	2,8	D
02853	BAGEF	63,5	102,50	7,0/22,5	I
02856	GAE	26,0	40,00	5,0	I
02859	BRGH	40,0	55,00	8,8	A
02862	BRAGF	44,7	61,20	8,8	A
02864	BRGE	12,4	29,00	7,8	D
02868	BRG	125,0	150,00	13,0	
02871	BRAGF	78,0	100,05	12,0	A
02872	BRAGF	130,0	160,00	12,0	A
02873	BRG	6,0	16,00	6,5	
02874	BAY	59,9	85,40	22,9	M
02875	GRG	16,0	23,00	3,3	A
02876	GRG	16,5	25,00	5,0	A
02877	BAG	28,6	41,25	6,5	
02878	BAG	22,2	31,00	6,0	
02879	BAG	41,3	54,00	6,5	
02880	BG	44,5	73,00	12,7	
02886	NES	9,5	13,45	18,6/20,8	F
02890	NES	9,5	13,45	8,6/10,8	F
02892	NES	7,9	13,45	13,5/15,7	F
02893	BRAGP	40,0	56,00	7,0	A
02894	BY	106,5	140,00	15,0	M
02898	BRAGF	81,0	100,10	11,5	A
02900	BRAGF	90,0	104,00	11,0	A
02903	GRO	35,0	48,50	5,0/7,0	A
02904	GAE	12,0	26,80	4,0	D
02905	BRGG	45,0	56,00	6,0/7,0	A
02906	BRGO	8,0	25,25	2,6	D
02910	BAGE	44,2	71,40	10,0/16,5	B
02911	BRAGP	40,0	55,00	8,0	A
02917	BRGE	22,0	35,20	3,8/12,0	D
02919	BREF	7,0	10,90	6,5/9,5	F
02925	BRAGF	85,0	105,00	12,0	A

Número Sabó	Tipo	Diâmetro do Eixo	Diâmetro do Alojamento	Altura do Retentor	Grupo
02927	BREF	8,7	13,45	7,6/11,0	F
02928	BRE	16,0	22,00	6,2/9,7	I
02929	BRGE	30,0	62,90	2,5/20,2	I
02930	BRGP	30,0	47,00	10,0	
02932	BAGF	150,0	180,00	15,0	
02933	BRG	150,0	180,00	15,0	
02934	GRE	8,0	16,00	2,3/3,5	D
02936	BRAGP	30,0	52,00	7,0	A
02938	BRAG	95,0	115,00	13,0	
02940	BRGO	7,0	22,50	3,6	D
02941	BRAG	125,0	150,00	15,0	
02946	BRAGP	70,0	85,00	8,0	A
02950	BRGF	32,0	47,00	10,0	
02952	BAGEP	21,8	-	48,4	T
02955	BRF	60,0	80,00	10,0	
02960	BAGEP	47,6	68,00	0,9/10,4	K
02961	BAGGP	70,0	90,00	12,7	A
02962	BRGF	35,0	47,00	7,0	
02963	BROF	17,0	30,00	7,0	A
02965	BRGG	47,0	60,00	7,0	A
02966	BRGG	30,0	47,00	8,0	A
02967	BRGE	23,0	37,00	7,0/11,0	A
02968	GAE	29,0	39,50	8,6	I
02969	BREF	8,0	12,70	7,6/11,0	F
02971	BREF	8,1	12,00	7,6/11,0	F
02972	BAG	40,0	55,00	8,0	
02973	BRAGF	110,0	130,00	13,0	A
02979	BA	43,0	52,00	6,5	
02981	GA	43,0	52,00	6,5	
02984	BRG	32,0	45,00	7,0	
02985	BRF	105,0	130,00	12,0	
02987	GR	32,0	45,00	6,5	
02990	BAGP	47,6	63,55	9,7	
02996	BRGEP	58,0	80,00	4,5/10,5	B
02997	BRGEP	90,0	115,00	4,1/13,0	B
03001	GAE	22,2	29,00	6,0	I
03002	GAE	52,0	59,00	7,0	I
03003	GRE	20,0	30,00	4,0	A
03004	BRG	20,0	38,00	6,0	
03005	BR	10,0	21,00	5,0	
03006	GAE	31,0	38,00	6,0	I
03009	BREF	23,3	29,70	1,8/4,3	B
03010	GR	19,0	35,00	2,2	A
03012	BA	17,0	28,00	7,0	
03013	BA	20,0	31,00	7,0	
03015	GR	8,0	17,00	38,0	D
03017	BAGF	80,0	100,00	10,0	
03019	BRAGEP	22,0	40,00	8,0	A
03026	GAE	30,0	61,95	0,9/5,0	K
03038	MGE	2,0	25,00	14,7	I
03044	BREF	7,0	9,80	6,2/10,0	F
03045	BREF	9,5	14,40	9,1/13,2	F
03110	BRGE	12,0	28,05	8,0	I

Número Sabó	Tipo	Diâmetro do Eixo	Diâmetro do Alojamento	Altura do Retentor	Grupo
03113	BRGH	14,0	26,85	10,1	A
03126	BRG	20,0	39,96	6,4	
03129	GR	31,8	45,03	3,6	
03164	GRG	42,0	58,00	7,0	
03202	GAEP	11,8	28,00	5,0/7,5	B
03232	NE	31,4	49,53	16,8	N
03245	BRH	31,8	44,73	6,4	A
03248	BRO	35,0	48,00	11,0	A
03249	BRO	31,0	43,00	10,3	A
03250	BRG	12,5	25,00	8,0	
03251	BRG	34,0	63,00	12,0	
03252	BRG	14,0	22,00	5,0	
03253	BRG	17,0	27,00	5,0	
03254	BR	5,0	14,50	4,5	
03255	BR	12,0	21,00	4,0	
03260	BRGGE	30,0	64,40	17,0	I
03281	GR	17,0	40,20	4,6	D
03301	MRP	-	28,00	7,0	H
03317	BAGP	52,0	70,00	8,0	
05003	BRAGS	35,0	48,00	7,0	
05005	BRAGS	35,0	48,00	7,0	
05049	BRGGF	15,9	30,00	2,0/8,0	A
05050	BRG	25,0	35,00	7,0	
05052	GAGE	28,2	45,92	0,8/5,5	K
05055	BRAGF	64,0	80,00	9,0	
05062	BRAG	64,0	80,00	8,0	
05073	BRAGF	30,0	52,00	7,0	
05074	BRAGF	30,0	43,00	8,0	
05075	BRAGF	74,0	90,00	10,0	
05093	BRAGF	30,0	42,00	7,0	
05117	BRG	30,0	42,00	6,0	
05126	BRG	60,0	76,20	11,1	
05139	GAGE	28,0	46,00	3,0	K
05141	BRA	17,0	28,00	7,0	
05142	BRA	20,0	31,00	7,0	
05148	BR	12,0	19,00	5,0	
05150	BRAGF	112,5	130,00	11,0	
05159	BRAGF	32,0	42,00	7,0/8,0	
05166	BRGS	79,0	95,30	11,0	
05167	BRG	36,6	52,35	8,0	
05183	GAGE	28,0	38,00	3,0	K
05199	GRGH	40,0	62,00	7,4	S
05202	BRAGP	30,0	47,00	7,0	
05210	GHSI	85,0	-	13,0	T
05228	GHSI	103,0	128,00	14,0	T
05229	GRAGGH	59,3	76,20	8,3	S
05230	GRAGH	110,0	130,00	9,3	S
05239	GHSIF	99,5	108,00	19,0	T
05250	BRGF	42,0	53,00	7,0	
05253	BRGF	35,0	50,00	7,0	
05254	BRGF	88,0	108,00	10,1	
05278	GHSI	104,0	128,00	11,0/14,0	S
05287	GRGH	130,0	150,00	12,0	S

Número Sabó	Tipo	Diâmetro do Eixo	Diâmetro do Alojamento	Altura do Retentor	Grupo
05304	BRAGF	85,7	114,33	13,0	
05305	BRGF	58,0	74,00	10,0	
05307	BRGP	34,0	48,00	7,0	
05308	BRGP	50,8	69,85	11,0	
05309	BRGP	53,0	69,85	11,0	
05338	PHSI	79,0	-	21,0	T
05343	BRAGF	90,0	104,00	11,0	
05352	BRGF	57,0	71,00	9,0	
05353	BRGF	46,7	62,00	9,0	
05363	BRG	37,0	47,00	10,2	
05411	BA	42,0	58,00	7,0	
05413	GRGG	57,5	74,00	8,5	A
05414	BRAGF	155,0	180,00	15,0	
05420	BRGF	90,0	110,00	9,0	
05421	BRGF	101,6	125,00	13,0	
05502	GHSI	85,0	-	13,0	T
05521	BRAGF	80,0	98,00	10,0	
05522	BRAGF	44,7	61,20	8,8	
05529	BRGP	32,0	48,00	8,0	
05530	BRGP	30,0	44,00	7,0	
07002	GRG	15,0	24,00	6,0	A
07012	BRGP	45,0	60,00	8,0	
07021	BRGP	40,0	55,00	8,0	
07022	BRGP	30,0	43,60	7,0	
07023	GA	53,0	82,00	7,5	
07062	BAGP	41,2	63,50	8,0	
07063	BRAG	15,0	21,00	5,0/6,5	A
07065	BR	55,0	72,00	10,0	
07078	BR	7,7	14,65	5,0	
07121	BR	99,9	130,00	12,0	
07126	BAGE	38,1	60,30	12,7/17,7	B
07134	BGE	21,0	32,00	7,0	A
07137	BGEP	22,8	40,00	6,5/8,0	A
07138	BGEP	29,8	52,00	10,0/13,5	B
07139	BGEP	29,8	50,00	10,0/13,5	B
07148	BRAGEP	28,0	-	54,5	T
07181	BR	57,1	76,05	12,7	
07198	MR	-	20,0	4,0	H
07199	BGEP	38,1	60,30	12,7/15,9	B
07217	BY	40,0	69,00	15,4	M
07220	BRG	89,0	114,00	13,0	
07240	BGEP	21,8	-	48,4	T
07262	BAGGP	57,2	82,50	12,0	
07266	S	17,5	50,00	21,5	U
07267	BAGP	57,2	82,50	12,0	
07281	BAE	144,6	170,00	15,0/20,6	B
07284	BRAG	40,0	55,00	8,0	
07286	BR	21,5	40,00	7,0	
07290	BRAGF	75,0	95,00	10,0	
07298	MR	-	52,00	6,5	H
07299	BA	30,0	58,10	11,0	
07300	SIST.BY	39,9	68,90	15,4	T
07303	BA	38,1	47,60	7,0	

Número Sabó	Tipo	Diâmetro do Eixo	Diâmetro do Alojamento	Altura do Retentor	Grupo
07309	BRAGP	22,8	40,00	8,0	
07313	MR	-	20,00	4,0	H
07322	BRA	100,0	125,00	12,0	
07323	BRG	100,0	129,90	13,0	
07340	BAYF	121,1	160,00	35,0	M
07364	BRAGP	34,0	52,00	7,0	
07365	BRAGF	45,0	65,00	10,0	
07369	BG	100,0	119,95	13,0	
07372	BRAG	119,5	144,95	15,0	
07375	BY	82,5	114,30	12,7	M
07381	BAG	41,0	65,40	13,0	
07387	GAE	40,0	66,00	7,0	A
07390	GRAGX	12,0	18,00	8,0	G
07395	BRAGGG	47,7	73,10	9,5/17,5	A
07397	BRAGP	15,0	21,00	5,0	
07398	BAGEF	35,0	54,90	8,9/14,7	B
07399	BRP	35,0	56,00	10,0	
07408	BRGP	11,6	24,00	10,0	
07409	BRP	17,0	29,00	5,4	
07414	BGE	88,9	115,40	16,2/19,2	B
07415	BGE	88,9	122,95	18,7/21,7	B
07416	BY	98,4	144,00	16,0	M
07425	GAGGE	61,5	76,15	7,1	I
07439	BYF	82,5	114,30	12,7	M
07461	BRF	117,4	142,87	12,5	
07481	BRABGEF	40,0	70,00	13,0/20,0	L
07484	BRAGF	60,0	73,00	10,5	
07485	BAF	48,0	69,00	10,0	
07496	BGE	21,0	32,00	9,0	A
07500	BRAGEF	42,0	72,00	10,0/16,0	B
07502	MR	-	52,00	8,0	H
07538	BRAGEP	29,8	52,00	10,0/13,5	B
07539	BRAGEP	29,8	50,00	10,0/13,5	B
07599	BAF	46,0	68,00	12,0	
07603	BRAF	68,0	85,00	10,0	
07679	S	17,5	50,00	21,5	U
09203	BREF	6,0	8,80	6,1/9,4	F
09205	BREF	11,0	14,00	10,0/14,0	F
09211	BAEF	9,0	13,00	10,0	F
09212	BAEF	8,0	14,00	8,0	F
09228	BREF	7,0	11,00	7,0/10,2	F
09239	BREF	7,0	11,00	7,0/10,2	F
09242	BREF	8,0	11,95	7,0/10,9	F
09250	BREF	6,0	11,00	17,8	F
09255	BREF	7,0	11,00	7,0/10,0	F
09260	BREF	6,0	12,00	19,4	F
09261	BAEF	7,0	12,00	10,0	F
09262	BAEF	8,0	13,00	10,0	F
09266	NEF	5,5	9,20	7,0/8,0	F
09271	BAEF	8,5	14,10	13,5	F
09802	NG	12,4	24,50	6,3	D
09803	GR	8,0	16,50	2,3	D
09804	BRGO	20,0	45,25	5,3	D

Número Sabó	Tipo	Diâmetro do Eixo	Diâmetro do Alojamento	Altura do Retentor	Grupo
09807	GRE	31,7	42,15	4,2	D
09808	GRE	31,7	42,85	4,2	D
09810	BRO	22,0	35,70	3,7/12,0	D
09811	BRO	20,0	31,80	3,3/10,1	D
09820	BRGO	20,0	32,00	2,8	D
09821	BRGO	22,0	33,95	2,8	D
09829	GR	8,0	16,50	2,3	D
09832	BROE	22,0	38,90	3,2	D
09836	BROE	25,0	42,75	3,2	D
09837	GR	10,0	19,50	2,3	D
09839	BRGE	22,0	35,55	3,5	D
09841	BRGE	12,4	31,72	3,4	D
09843	BRO	20,0	31,70	3,3	D
09845	BRGE	22,0	35,55	3,5	D
09849	BRGE	20,0	40,95	6,0	D
09854	BRGE	12,4	39,40	5,3	D
09855	BRGE	15,7	48,15	5,3	D
09856	BRGE	20,0	40,40	6,0	D
09866	BRGO	10,0	27,10	3,6	D
09867	BROE	20,0	38,90	3,2	D
09870	BROE	40,0	47,23	4,8	D
09881	NG	12,4	23,50	6,1	D
09903	BROE	22,0	42,75	3,2	D
09906	BRGE	18,0	40,70	5,3	D
10026	ME	46,0	51,70	20,0	R
10131	ME	57,3	90,10	7,5	R
10141	ME	28,5	30,70	6,5	R
10143	GE	29,8	42,30	29,5	I
10144	GE	42,2	53,20	25,5	I
10145	GGE	22,0	42,50	29,5	I
10316	MGE	2,0	24,50	14,7	I
10409	MR	-	27,50	7,0	H
10410	MR	-	27,50	7,0	H
10411	MR	-	28,00	7,0	H
10412	MR	-	28,00	7,0	H
10413	S	30,0	111,00	20,7	U
10415	MRP	-	68,00	8,5	H
10416	S	21,9	52,80	2,0/21,6	U
10418	G	17,5	-	1,6	J
10420	MR	-	16,00	7,0	H
20063	G	17,5	25,00	4,8	N
20072	G	4,0	10,50	3,2	N
20083	U	15,0	21,50	3,2	C
20144	G	22,9	34,80	26,7	N
20145	GE	19,7	31,75	18,0	N
20147	G	13,2	29,25	3,0	N
20148	G	7,2	19,25	3,0	N
20163	NE	-	69,80	3,0	N
20164	U	25,0	32,00	9,0	C
20165	U	28,0	38,00	8,0	C
20166	U	41,0	57,00	9,5	C
20167	U	44,0	60,00	12,0	C
20168	U	54,0	70,00	12,0	C

Número Sabó	Tipo	Diâmetro do Eixo	Diâmetro do Alojamento	Altura do Retentor	Grupo
20169	U	62,0	70,00	9,0	C
20170	U	12,0	22,00	7,6	C
20171	U	36,0	52,00	12,0	C
20172	NE	4,0	12,00	8,0	N
20175	U	16,0	27,00	7,5	C
20177	U	30,0	39,00	4,8	C
20178	U	12,3	18,60	2,5	C
20180	G	8,7	-	0,9/1,6	J
20181	U	16,0	22,00	6,0	C
20202	UF	8,0	14,00	4,0	C
20204	NEH	22,2	28,60	6,5	C
20205	NEF	17,0	21,50	15,0	N
20210	UE	157,0	170,30	19,5	N
20235	U	14,0	23,20	3,2	C
22030	G	8,3	-	1,5/1,9	J

Edição da SABÓ SISTEMAS AUTOMOTIVOS LTDA.
Rua Matteo Forte, 216 – Lapa – São Paulo – Brasil
CEP 05038-160 – Tel. Vendas: (11) 3677 2600
Fax: (11) 3677 2841/2888
<http://www.sabo.com.br>
e-mail: vendas@sabo.com.br

© SABÓ SISTEMAS AUTOMOTIVOS LTDA. 2001
Todos os direitos reservados. Nenhuma parte deste Catálogo poderá ser reproduzida, arquivada ou utilizada, nem copiada de forma alguma, por nenhum meio, eletrônico, impresso, fotocopiado, gravado, ou ainda por qualquer outro meio, sem permissão escrita antecipada da Sabó Sistemas Automotivos Ltda. Todo o material contido neste Catálogo foi compilado de fontes seguras de informação. Apesar de todo o cuidado empregado em sua preparação, não é possível garantir total exatidão destas informações e por consequência, nenhuma responsabilidade pode ser aceita por eventuais erros, omissões, bem como perdas ou danos assim decorrentes. 05/01

Tipos Básicos Legendas

- BR** - Vedação principal de borracha com mola, recoberto externamente com borracha.
- BRG** - Vedação principal de borracha com mola, proteção contra poeira e recoberto externamente com borracha.
- BA** - Vedação principal de borracha com mola, e diâmetro externo de metal.
- BAG** - Vedação principal de borracha com mola, proteção contra poeira e diâmetro externo de metal.
- B** - Vedação principal de borracha com mola, diâmetro externo de metal e com tampa.
- BG** - Vedação principal de borracha com mola, diâmetro externo de metal, proteção contra poeira e com tampa.
- GR** - Vedação principal de borracha sem mola e diâmetro externo recoberto com borracha.
- GA** - Vedação principal de borracha sem mola e diâmetro externo de metal.

Estrias do Lábio (orientação)

- L = Liso
- H = Horário
- AH = Anti-horário
- BI = Bidirecional
- RE = Rosca esquerda

Material do Lábio

- NBR = Nitrílica
- ACM = Poliacrílica
- MVQ = Silicone
- FPM = Fluorelastômero
- PU = Uretano
- CR = Neoprene
- FE = Feltro
- PTFE = Teflon
- PH = Velumoid
- CO = Couro
- NY = Nylon
- M = Metal
- PA = Amianto
- HNBR = Hidrogenada